

FOR SCHINDLER / WESTINGHOUSE QUICK LOCATOR GUIDE

Belts	803
Brushes	804-809
Brush Holders	810
Capacitors	832
Car Signal Components	794-802
Gongs	802
Emergency Stop Switch.....	798-799
Key Switches and Keys	794-796, 800
Lantern Lens.....	801
Position Indicators	800
Pushbutton Assemblies	794, 799
Switches, Rocker and Reed	802
Coils	812-814
Door Parts And Equipment	815-831
Cables and Pulleys	817, 826, 829-830
Door Keys and Escutcheons.....	823
Door Roller Assemblies	827
Gibs, Guides	823-824
Hatch Equipment.....	850-853
Interlock Components	815, 818-820
Door Motors.....	817, 828, 830
Operators	825-828
Safety Edge Parts	821
Spirator, Reel Closer.....	822, 826
Track Liner.....	857
Electronics - Tubes, Breakers, Fans	832-833
Machine Parts	834-838
Gaskets, Seals and Bearings	834-838
Motors	828
Printed Circuit Boards	839-843
Rectifiers	832
Relays	845
Relay Components	846-850
Replacement Spring Clips	811
Resistors	844
Selector Components	851
Switches	850, 852
Transformers	855
Wheels And Rollers	855-861
Hanger Assemblies.....	855-857
Hanger Rollers.....	855-856, 858
Roller Guide Assemblies	860
Roller Guide Wheels.....	858

Car Signal Components

S.E.E.S. #	O.E.M. #	Description
SB-1	8544C17G04	Button Housing , with lens
SB-1BR-	6954C71H01	Braille Plate , braille for SB-1 housing or SB-6 assembly, Stainless Steel, 1" x 1.187" (specify marking)
MIS-BR1.25-		Braille Plate , for SB-6-VAN assembly, Stainless Steel, 1.25" x 1.25" (specify marking)
SB-2	8540C58H02	Button Retainer Bracket
SB-2A	70010CSC3R	Screw , 6-32 x 1/2" Hex Washer Head, Slotted
SB-3	7283C730G02	Printed Circuit Board Assembly for pushbutton, two micro switch type
SB-4	7283C730G01, 998C278H11	Printed Circuit Board Assembly for pushbutton, one micro switch type
SCH-KCY-001	D3158-057A/AS100	Key Switch , PHI, 3 position with AS100 key
SCH-KCY-002	D3158-057B/AS100	Key Switch , PHII, 3 pos, AS100 key, per yr. 2000 code
SCH-KCY-004		Key Switch , 2 Pos, Rmv 2 with 100T Key
SCH-KCY-005		Key Switch , 2 Pos, Rmv 1 Spring Ret with OCO-1 Key
SCH-KCY-005A		Key Switch , 2 Pos, Rmv 2 with 2 OCO-1 Keys
SCH-KCY-006		Key Switch , 2 Pos, Rmv 1 Spring Ret with OCO-4 Key
SCH-KCY-007		Key Switch , 2 Pos, Rmv 1 Spring Ret with AS100 Key
SB-5	8544C19G01	Jewel , MT style, Fire Service Light
SB-6	8544C17G01	Pushbutton Assembly 2-SW
SB-6-VAN		Vandal Proof Pushbutton Assembly , 24V 1 N.O. SW Cont. Replaces MPH Style Buttons for Schindler
SB-6-VAN-A		Vandal Proof Pushbutton , 6V-120V 1 N.O./1 N.C. Switch, White Replaces MPH Style Buttons
SB-7	6947C64G02	Stop switch assembly
SB-8	7275C63G01	Button , white



SB-1



SB-1BR-7



SB-2



SB-2A

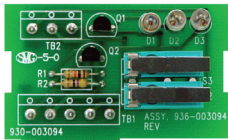

SB-3

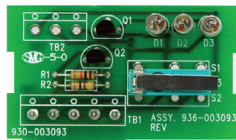

SB-4



SCH-KCY-001



SCH-KCY-002



SB-5



SB-6

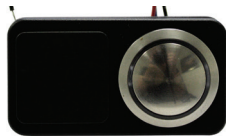

SB-6-VAN



SB-6-VAN-A



SB-8

Car Signal Components

S.E.E.S. #	O.E.M. #	Description
SB-10L		For Schindler Button, Standard LH 330A
SB-10R		For Schindler Button, Standard RH 330A
SB-11L		For Schindler Button Base, LH 330A
SB-11R		For Schindler Button Base, RH 330A
SB-12		Button, Hall Station White Arrow
SB-13		Corridor Button Base Assembly For Hall Station
SB-14	5227D40H01	COP Perimeter Frame, Black Plastic for 330A
SB-1BR-3R		Braille, "3R" Braille for SB-1 Housing
SB-1BR-B		Braille, B For SB-1
SB-1BR-L		Braille, "L" Braille for SB-1 Housing
SB-1BR-LL		Braille, "LL" Braille for SB-1 Housing
SB-1BR-M		Braille, M for SB-1
SB-1BR-STAR-2		Braille, *2 for SB-1
SB-1BR-STAR-G		Braille, *G for SB-1



SB-10L



SB-10R



SB-11L



SB-11R



SB-12



SB-13



SB-1BR-B



SB-14

FOR SCHINDLER / WESTINGHOUSE

Car Signal Components

S.E.E.S. #	O.E.M. #	Description
SK-1	AS100	Key, PHI & PHII fire service key AS100
SK-2	100-T	Key, #100-T car panel key
SK-3	OCO-1	Key, for Schindler OCO-1 Hoistway Access key
SK-4	OCO-4	Key, for Schindler OCO-4 Industrial Service key
SK-5	H301	Key, for Schindler H301 STOP-RUN key
SK-6	WDO1	Key, Fire Service, WDO1
SK-8	501CH	Key, Access 501CH S
SK-9	MM101	Key, General Service MM101
SK-10	J222	Key, J222
SK-11	J217	Key, J217
SK-12	AS110	Key, AS110
SK-13	LDU	Key, LDU Access



SK-1



SK-2



SK-3



SK-4



SK-5



SK-6



SK-8



SK-9



SK-10



SK-11



SK-12

Car Signal Components

S.E.E.S. #	O.E.M. #	Description
SKS-1	8544C14H01	Bezel , key switch bezel only for MTA key switches
SKS-1A	7254C77H18	Face Plate , Blank Black MTA key switch for SKS-1
SKS-2	8544C18G02	Key Switch , Fire Service, MTA PH1, 3 Pos. ON/OFF/ BYPASS, use SK-1 key, with AS100 Key
SKS-2A	8544C18G01	Key Switch , Fire Service, MTA Style, PH II, SK-1 key, 3 Pos. OFF/HOLD/ON, with AS100 Key
SKS-2B		Fire Service Key Switch , MT Style PH 1 with H341 key
SKS-2C		Fire Service Key Switch , MT Style PH 2 with H341 key
SKS-2D		Fire Service Key Switch , MT Phase I, 3 Position, Rem 2 On Off, Reset, with AS100 Key
SKS-2-FAN		Key Switch , Fan, High-Off-Low 3 Pos, Rmv 3 with USE#2 Key
SKS-2-IND-SERV		Key Switch , Ind Serv, Off-On 2 Pos, Rmv 2, UTC Key
SKS-3B		Key Switch , 2 Pos Rem 1 Momentary Off, On with OCO-1 Key
SKS-4	A5468AA101	Key Switch , Fire Service, PHI Hall, uses SK-6 Key
SKS-5	A5468A201	Key Switch , Fire Service, PHII CAR, uses SK-6 Key
SKS-5A		Key Switch , Fire Service, PH II, 2 Pos/Rem. 2 with DO1 Key
SKS-6		Key Switch , 2 Position, Removal 2 Key H301
HK-1	3-40079-51	Key only for SKS-3 ACECLC332
WK-2	H200	Key , Utility Door Key #H200

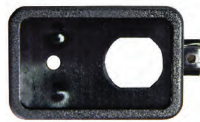

SKS-1



SKS-1A



SKS-2



SKS-2A



SKS-2-FAN



SKS-5



SKS-5A

Car Signal Components

Type A Hall Station

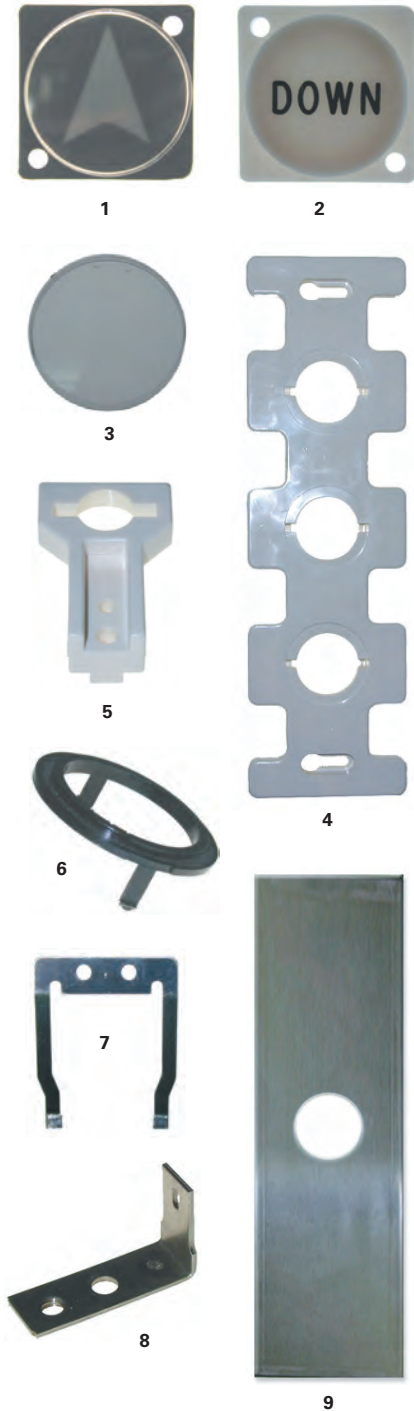

Fig.	S.E.E.S. #	O.E.M. #	Description
1	WB-1-	477C742G	Button , black square base with 1" diameter button with white marking, and clear cap (specify marking)
2	WB-2-	477C742G	Button , white square base with 1" diameter button with black marking, and clear cap (specify marking)
3	WB-6A	146A560H05	Clear Cap
4	WB-6B	477C740H01	Base , Button base plate
5	WB-6E	151B605H01	Lamp Socket Holder
6	WB-7	569A997H01	Ferrule , Lexan
7	WB-9	151B608G01	Movable Contact Bridge , N.O.
8	WB-11	151B616G01	Stationary Contact , N.O.
9	WB-19	577C549G01	Cover Plate , 1 button, stainless steel, 3" W x 10" H. 1-1/4" dia. button hole
	WB-20	577C549G02	Cover Plate , 2 buttons, stainless steel, 3" W x 10" H. 1-1/4" dia. button hole
10	WB-21	T8474	Cover Plate , Stainless steel cover plate 3" W x 10" H, with arrows, shield and hardware, uses WB-22 Arrow
11	WB-22	K64201	Arrow , White frosted arrow, 2-1/2", Lexan
12	WB-28	681A508H02	Lamp Socket with leads
	WB-31	866A123H01	Lamp Socket with insulator for 60MB lamp
13	ML-7	X46AS3H44	Lamp 90V
	ML-6	X46AS2H20	Lamp 120V

Car Signal Components

Type A Hall Station

S.E.E.S. #	O.E.M. #	Description
WB-6C	1718C78H01	Hall Base Plate for rotodial Type "A"
WB-6D	2638C89G02	Hall Pushbutton Station Complete, Type AE
WB-6F	198C578G01	Base Plate Alone for WB-6D Type AE button
WB-6G		Clamp, button assembly

Types A and AE

S.E.E.S. #	O.E.M. #	Description
WB-5-	103D251H	Button, 1.125" Type A, black button with white marking, specify marking i.e. WB-5-1
WB-6-	103D250H	Button, 1.125" Type A, white button with black marking, specify marking i.e. WB-6-1
WB-6-ARROW	103D250H	Button, White, Car Station, Up or Down Arrow
WB-6A	146A560H05	Clear Cap, raised ADA clear cap for E line buttons
WB-6AE-	5204D64H	Button, Type AE white button with black marking, specify marking, i.e. WB-6AE-2

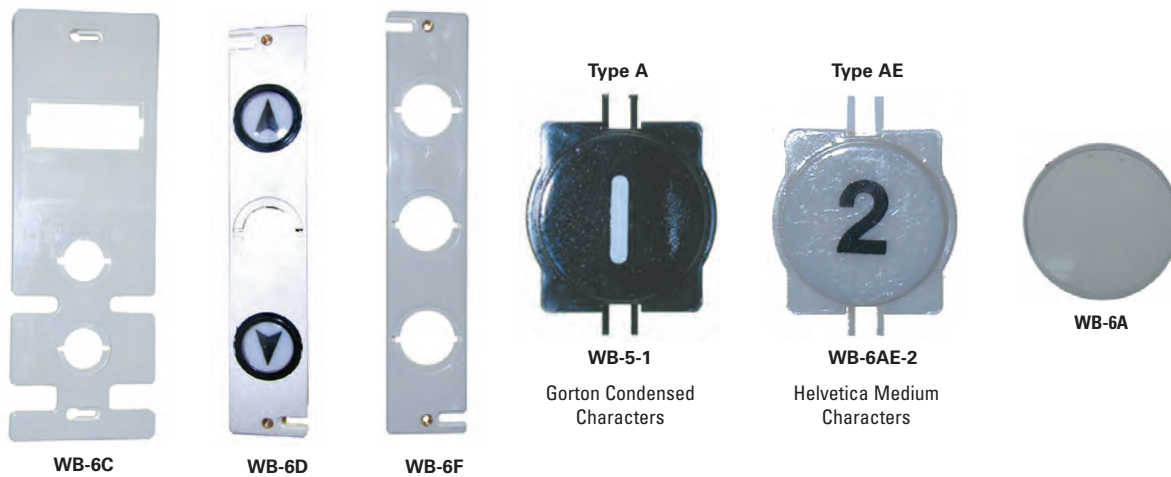

Car Signal Components

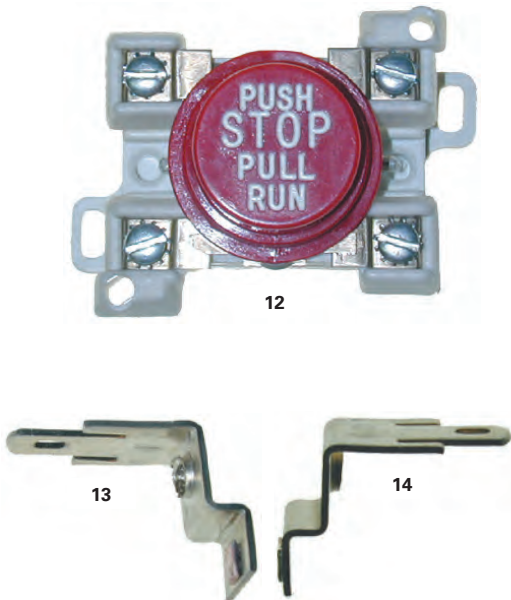
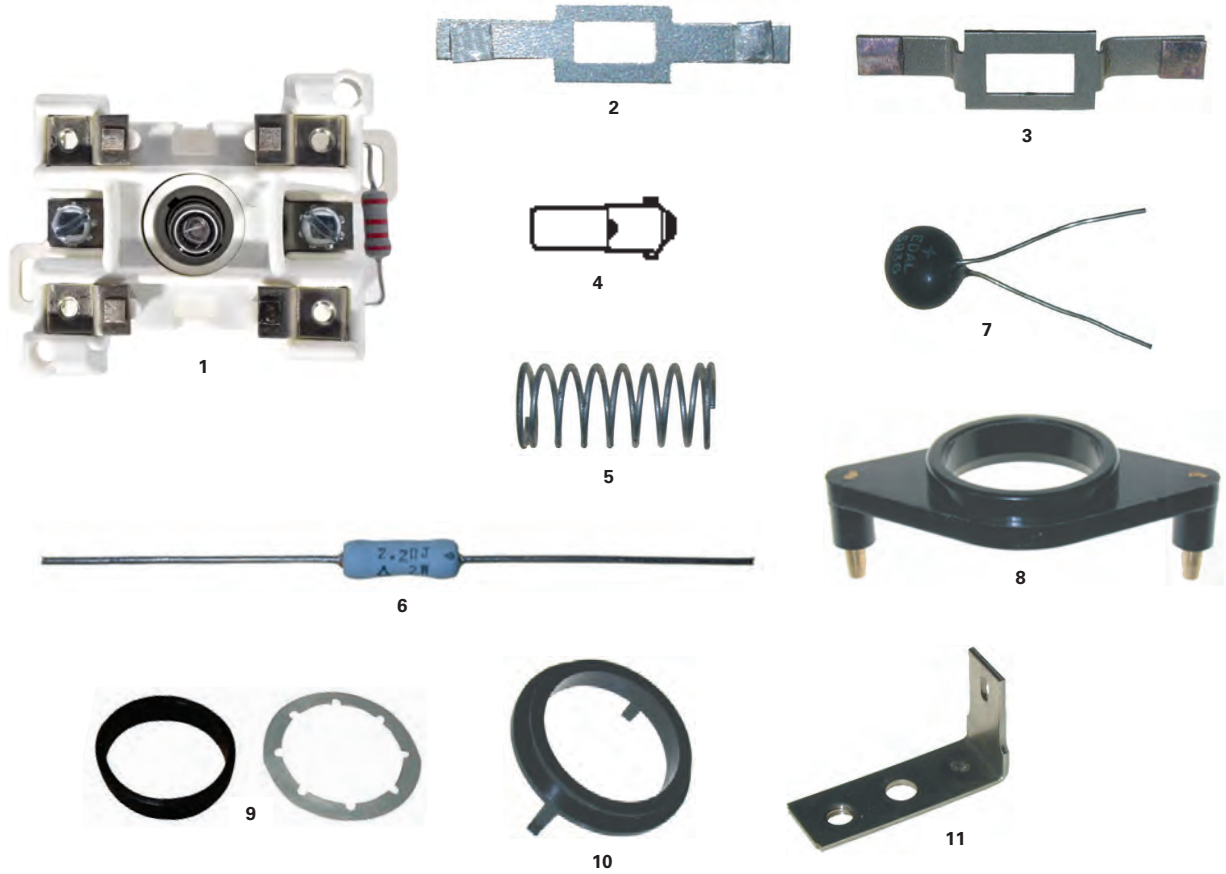

Fig.	S.E.E.S. #	O.E.M. #	Description
1	WB-23	630B899G0	Base for 2 make
	WB-23A	630B899G03	Base for 1 make, 1 break
	WB-23B	630B899G01	Base for 1 make
2	WB-12	151B439G01	Contact Bridge, Making
3	WB-13	151B439G02	Contact Bridge, Breaking
4	ML-6	X46AS2H20	Lamp, 120V
	ML-7	X46AS3H44	Lamp, 90V
5	WB-27	X9JS1H27	Spring
6	WB-23C	73432BS0Q8	Resistor, 2.2K, 1W
7	WB-23D	K6267H01	Rectifier
8	WB-25	630B562G01	Ferrule
9	WB-10	151B440H01	Ferrule for type "A" car
10	WB-26C	866A113H01	Ferrule for type "AE"
11	WB-11	151B616G01	Stationary Contact, open
12	WB-16	325C805H01	Emergency Stop Switch, complete
13	WB-17	W-456C4	Contact, N.C.
14	WB-18	W-456C3	Contact, N.O.

Car Signal Components



Type E Pushbutton Assembly

Fig.	S.E.E.S. #	O.E.M. #	Description
1	WB-4E12-		Pushbutton Assembly , two normally open contacts, specify marking
	WB-4E13-		Pushbutton Assembly , one normally open contact, specify marking
	WB-4E14-		Pushbutton Assembly , one normally closed contact, specify marking
	WB-4E15-		Pushbutton Assembly , one normally open and one normally closed contact, specify marking
2	WB-4E2	216B298H01	Base , Push button base
	WB-4E2A	196C698H02	Housing , deep recess for pushbutton assembly
3	WB-3-	323C854H	Button , White, with black marking, specify marking i.e. WB-3-1
4	WB-4-	323C854H	Button , Black, with white marking, specify marking i.e. WB-4-2
5	WB-6A	146A560H05	Clear Cap , raised ADA clear cap for E line buttons
	WB-6AB	W-454-BC1	Clear Cap , raised ADA clear cap for A line buttons
6	WB-4E3	145A390G02	Stationary Contact , normally open
7	WB-4E4	145A390G01	Stationary Contact , normally closed
8	WB-4E5	145A395G01	Movable Contact Bridge , normally open
9	WB-4E6	145A395G02	Movable Contact , normally closed
10	WB-4E7	145A391G01	Mounting Bracket
11	WB-4E8		Insulator
12	WB-4E9	X9J20	Spring , normally open, for E line buttons
13	WB-4E10		Spring , normally closed, heavy duty
14	WB-4E11		Screw , zinc plated steel
15	WB-4E1	576B294G01	Emergency Stop Switch Assembly
16	ML-42	X46AS1H05, H26	Lamp , clear 230V
	ML-34	X46AS1H06, H27	Lamp , red 230V
	ML-35	X46AS1H07, H28	Lamp , green 230V
	WB-39		Bezel , Red, blank, Fits Type E Pushbutton Fixture (Anodized Aluminum)
17	WB-39-		Bezel , Red, White marking, Fits Type E Pushbutton Fixture (Anodized Aluminum), specify marking i.e. WB-39-Hold-On-Fire
	WB-39A		Base , Black Fits Type E Pushbutton Fixture (Plastic)



Car Signal Components



WKS-1



WKS-4

Type E Key Switch Assembly

S.E.E.S. #	Description
WKS-1	Key Switch , Fire service, Phase I, 3 Position, Key removable in 2 positions ON & OFF only, Double Pole, Fits Type "E" Push button Fixture, Key # H341 or WK-1 key, Red, white marking, OFF/ON/FIRE/BYPASS, (Anodized Aluminum)
WKS-2	Key Switch , Fire service, Phase II, 3 Position, Key removable in all positions, Double Pole, Fits Type "E" Push button Fixture, Key # H341 or WK-1 key, Red, white marking, HOLD/ON/FIRE/OFF (Anodized Aluminum)
WKS-4	Key Switch , Run-Stop, 2 Pos 2KP, with UTC Key



1



2



2



3



4



5



6



7



8



9

Position Indicators Types A and AE

Fig.	S.E.E.S. #	O.E.M. #	Description
1	WB-24-	325C877G01	PI. Lens , Type A position indicator lens, white with black marking, i.e. WB-24-3
2	WB-26B-	5213D27G01	PI. Lens , Type AE position indicator lens, white with black marking, i.e. WB-26B-6
3	WB-6A	146A560H05	Clear Cap , raised ADA clear cap for E line buttons
4	WB-26	569A920H01	Ferrule , Type A
5	WB-26A	X4SS1H02	Nut , Speed nut
6	WB-26B	196C557H01	Ferrule , Type AE, includes speed nut
	WB-26C	366A113H01	Ferrule , Type AE insert
7	WB-14	569A868H01	Reflector funnel for lamp
8	WB-38	X46CS1H08	Lamp Fluorescent lamp
9	WB-32	681A790H01	Lamp Holder for A and AE signal

Car Signal Components

FOR SCHINDLER/WESTINGHOUSE

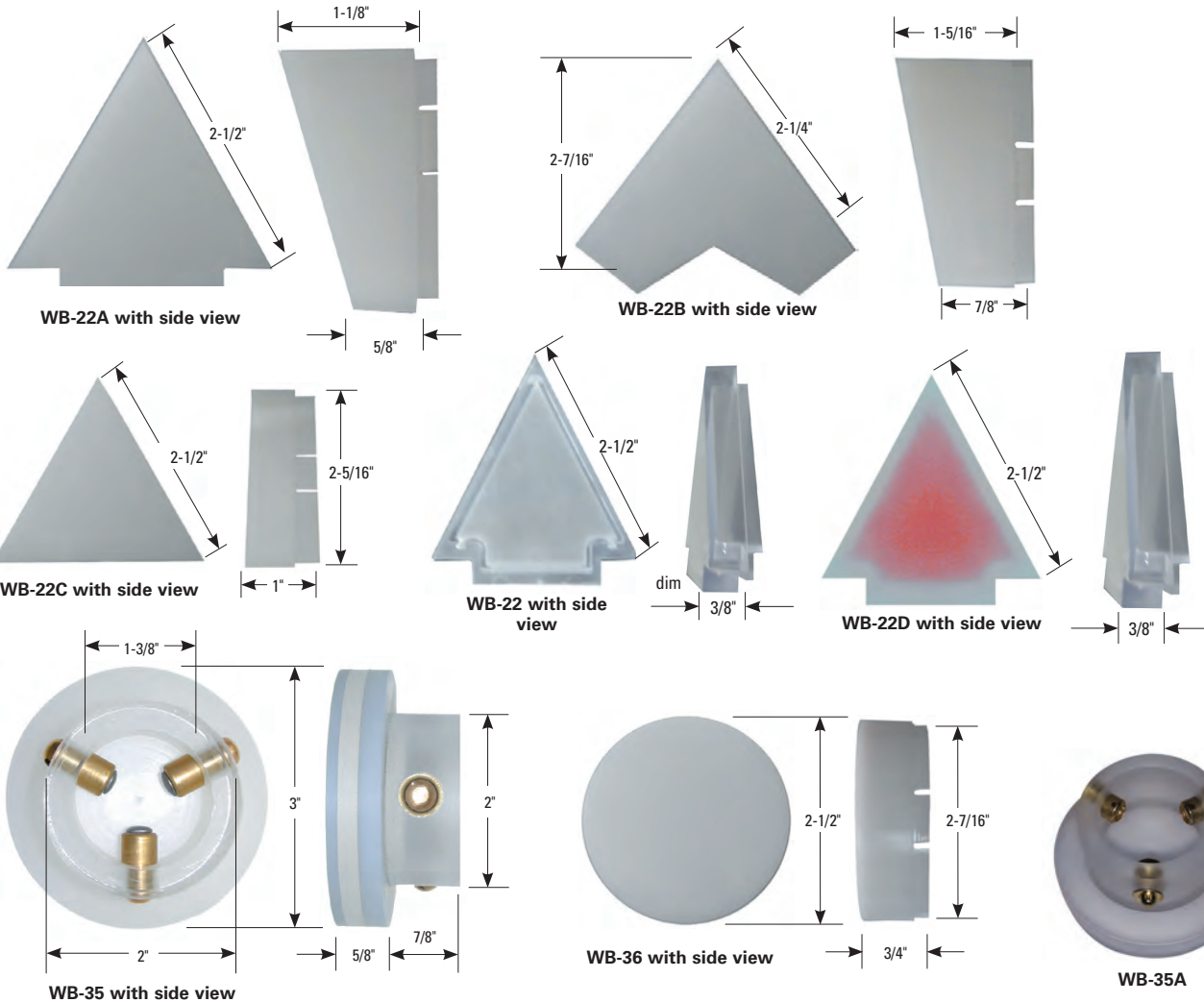

S.E.E.S. #	O.E.M. #	Description
WB-22A	103D605H01	Lens, Lantern lens, arrow, white frosted Lexan
WB-22B	103D605H02	Lens, Lantern lens, Chevron style, white frosted Lexan
WB-22C	1718C18H01	Lens, Lantern lens, arrow, white frosted Lexan
WB-22	K64201	Lens, White frosted arrow, 2-1/2", Lexan
WB-22D	630B023G01	Lens, White frosted arrow on red, 2-1/2", Lexan
WB-35	195C989G03	Lens, Round lens with bullet catches, 3" dia. x 1-1/4"
WB-35A		Round Lens, 3" OD x 5/8" W x 1" Neck, Clear Sandblasted
WB-35B		Square Lens, 4" x 4" with 2-5/8" Sq Back and Bullet Catch
WB-35C		Round Lens, 3" OD x 5/8" W x 1.875" Neck, Clear
WB-35D		Round Lens, 3-3/4" OD x 1/8" W x 1" Neck, Clear
WB-35E		Round Lens, 4" OD x 5/8" W with 3" OD x 7/8" L Neck, White/Clear
WB-35-SPECIAL		Round Lens, 3" diameter with bullet catch, special
WB-35F		Round Lens, 4" OD x 1/2" W with 2" OD x 2" L Neck, Clear Frosted, with Bullet Catches
WB-35G		Lens, 3" OD x 3/4, 1-3/4" OD x 7/8" Neck
WB-35H		Lens, 3" OD x 5/8, 1-3/4" OD x 7/8" Neck, Clear, No Diffuser
WB-35J		Round Lens, 3" OD x 5/8" W with 1-3/4" OD x 5/8" L Neck, White/Clear, Spring Pin & Set Screws
WB-36	103D605H03	Lens, Round lantern lens, 2-1/2" diameter x 3/4"



WB-35B



WB-35F

Car Signal Components

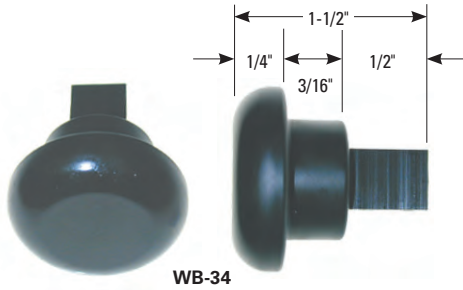

WB-34

S.E.E.S. #	O.E.M. #	Description
WB-34	K4912H01	Button , Black, Hall mushroom style pushbutton 1-1/8" diameter with stem
WB-29	569A925G01	Lock and Cam Assembly , uses key WB-29A
WB-29A		Key , only, #F359
WB-29C		Key , only, #F300
WB-29D		Lock and Cam Assembly , Keyed to AS100
WB-30	145A681H01	Mercury Switch
WB-37	151B514H02	M.G. Switch for car station, no spring return
WB-37A	151B74H01	Switch , Momentary Rocker Switch, (1-1/8" x 1-3/8" hole)
WB-37B	7257C63H06	Switch , Rocker DPDT for Car Top Inspection, maintaining
WB-33	576B583G01	Gong and Coil Assembly , 50-60 watt series, 2-1/2" diameter



WB-29



WB-30



WB-37



WB-37A

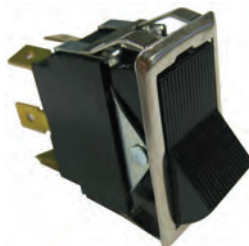

WB-37B



WB-33

*Don't see what you're looking for?
Please inquire. We are constantly adding
new items to our inventory.
Today's special orders are tomorrow's stock parts!*

Belts

Timing Belts, 3/8 Pitch

S.E.E.S. #	O.E.M. #	Width	Teeth	Circ.
WBLT-1	144A600H04	1/2"	64	24"
WBLT-2	144A600H01	1/2"	68	25-1/2"
WBLT-3	144A600H15	1/2"	72	27"
WBLT-4	144A600H14	1/2"	76	28-1/2"
WBLT-5	144A600H18	1/2"	86	32-1/4"
WBLT-6	144A600H02	1/2"	120	45"
WBLT-7*	144A600H10	1/2"	120	45"
WBLT-8	144A600H13	1/2"	144	54"
WBLT-9	144A600H12	1/2"	160	60"
WBLT-10	144A600H16	1/2"	176	66"
WBLT-11	144A600H05	1/2"	194	72-3/4"
WBLT-12	144A600H27	1"	120	45"
WBLT-14	144A600H07	1"	144	54"
WBLT-15	144A600H09	1"	160	60"
WBLT-16	144A600H08	1"	176	66"
WBLT-17	144A600H11	2"	120	45"

*Steel reinforced.

S.E.E.S. #	O.E.M. #	Description
WBLT-18	144A417H02	Timing Belt for "E" door operator, 81-3/4" x 1/2"
WBLT-18A	144A417H01	Timing Belt, steel cord, for "E" door operator, 81-3/4" x 1/2"
WBLT-28	144A600H28	Timing Belt, 136 teeth, 1" W, 51" circ., 3/8" pitch
WBLT-19	144A416G01	V-Belt for "E" door operator, 99" L
WBLT-27	144A416H03	V-Belt for E Operator, 5/8" x 100" L
WBLT-20	691B789H05	Drive Belt, steel cord, for "BB" and "BT" escalators, 1" W, 140" circumference, 1/2" pitch
WBLT-20A	691B789H07	Drive Belt, steel cord, for "BB" and "BT" escalators, 1" W, 170" circumference, 1/2" pitch
WBLT-20A-FG		Drive Belt, 1/2P, 170" x 1" - Fiberglass Cord
WBLT-20-FG		Drive Belt, "BB&BT" ESC. 1/2PX1WX 140 C - Fiberglass Cord
WBLT-20G	693B415H01	Belt, door operator 7 rib for QKS-16 operator
MDO-1	5207D42H46	V-Belt, 4L550 (EZ/QKS-14/15 door operator)

S.E.E.S. #	O.E.M. #	Description
WBLT-21	X40AS1H10	V-Belt, 43" L, for "S" and "MS" operators
WBLT-22	X40AS1H11	V-Belt, 61" L, for "MIS" operators
WBLT-23	569A957H06	Drive Belt, 3-1/4" W x 81.5" circ., 20 grooves run the length of the belt
WBLT-24	569A957H04	Pump Belt, 71.5" circ., 20 grooves
WBLT-26	569A957H07	Pump Belt, 69.5" circ., 10 grooves

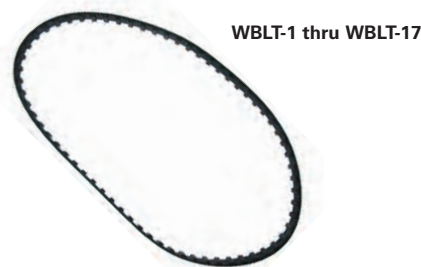

WBLT-1 thru WBLT-17



WBLT-18, WBLT-18A



WBLT-20, WBLT-20A



WBLT-20A-FG



WBLT-20-FG



WBLT-21, WBLT-22

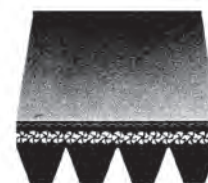

WBLT-23 Cross Section



WBLT-23



Brushes



WCB-12



WCB-17



WCB-24



WCB-147



WCB-26 thru WCB-28



WCB-28A

S.E.E.S. #	O.E.M. #	Grade	Shunt Length	Thick. x W x L
WCB-1A	X38A78	E36	3	.472 x .787 x 1-1/4
WCB-139	X38A93	N5000	4-1/8	3/8 x 1-1/4 x 2
WCB-140	E56019	H44	5	3/8 x 1-1/4 x 2
WCB-1	X38A62	W128	3	3/8 x 3/4 x 1-1/4
WCB-2	X38A65	W805	3	3/8 x 3/4 x 1-1/2
WCB-3	X38A74	W2065	3	3/8 x 3/4 x 1-1/2
WCB-4	X38A64	W805	3	3/8 x 1 x 1-1/2
WCB-5	X38A73	W784	3	3/8 x 1 x 1-1/2
WCB-6	X38A63	W128	3	3/8 x 1 x 1-1/2
WCB-7	X38A12	WP11	3-1/2	3/8 x 1 x 1-1/2
WCB-8	X38A13	WA25	4-1/4	3/8 x 1 x 1-1/2
WCB-9	X38A3	WM56A	3	3/8 x 1 x 1-3/4
WCB-10	X38A6	WM60	3	1/2 x 1 x 1-3/4
WCB-11	X38A16	WM56A	3	1/2 x 1 x 1-3/4
WCB-12	X38A39	WP11	3	1/2 x 1 x 1-3/4
WCB-14	X38A36	WP11	3	5/8 x 1 x 1-3/4
WCB-15	X38A68	W805	3	5/8 x 1 x 1-3/4
WCB-16	X38A4	WM60	3	3/8 x 1-1/4 x 1-3/4
WCB-17	X38A69	W805	3	3/8 x 1-1/4 x 1-3/4
WCB-18	X38A67	W805	3	1/2 x 1-1/4 x 1-3/4
WCB-19	X38A75	W784	3	1/2 x 1-1/4 x 1-3/4
WCB-20	X38A32	WP11	3	1/2 x 1-1/4 x 1-3/4
WCB-21	X38A7	WM60	3	1/2 x 1-1/4 x 1-3/4
WCB-22	X38A9	WM56A	3-1/2	1/2 x 1-1/4 x 1-3/4
WCB-23	X38A17	WM56A	3	5/8 x 1-1/4 x 1-3/4
WCB-24	X38A40	WP11	3	5/8 x 1-1/4 x 1-3/4
WCB-147	X38A30	N5000	3	5/16" x 1-1/4" x 2"
WCB-147A	X38AB8	H44	4-1/4	3/8" x 1-1/4" x 2"

S.E.E.S. #	O.E.M. #	Grade	Length	Thick. x W x L
WCB-26	X38B7	W805	3	3/8 x 3/4 x 1-1/4
WCB-27	X38B8	WL276	3	3/8 x 3/4 x 1-1/4
WCB-28	X38B9	W2064	3	3/8 x 3/4 x 1-1/4

WCB-28A	X38BS1H12		3	3/8 x 3/4 x 1-1/4
WCB-123A	X38RS3H36		2-3/4	3/8 x 1 x 1-1/4



WCB-123A

S.E.E.S. #	O.E.M. #	Grade	Shunt Length	Thick. x W x L
WCB-30	X38C18	W805	3	3/8 x 1 x 1-3/4
WCB-31	X38C21	W784	3	3/8 x 1 x 1-3/4
WCB-32	X38C14	W805	3	1/2 x 1 x 1-3/4
WCB-33	X38C22	W784	3	1/2 x 1 x 1-3/4
WCB-34	X38C6	Graphite	3	1/2 x 1-1/4 x 1-3/4
WCB-34A	X38C6	Carbon	3	1/2 x 1-1/4 x 1-3/4
WCB-35	X38C8	W128	3	1/2 x 1-1/4 x 1-3/4
WCB-36	X38C15	W805	3	1/2 x 1-1/4 x 1-3/4
WCB-37	X38C23	W784	3	1/2 x 1-1/4 x 1-3/4
WCB-38	X38C20	W510	3	1/2 x 1-1/4 x 1-3/4
WCB-39	X38C19	WL276	3	1/2 x 1-1/4 x 1-3/4
WCB-40	X38C16	W805	3	3/8 x 1-1/2 x 1-3/4
WCB-41	X38C24	W784	3	3/8 x 1-1/2 x 1-3/4
WCB-45A	X38C4	N5000	3-1/8	3/8 x 1-1/2 x 1-3/4
WCB-43	X38C25	W784	3	1/2 x 1-1/2 x 1-3/4
WCB-44	X38C17	W805	3	1/2 x 1-1/2 x 1-3/4
WCB-45B	X38C2	N5000	3-1/4	1/2 x 1-1/4 x 1-3/4
WCB-45C	X38C30	N5000	3-1/8	1-3/8 x 1-1/2 x 1-3/4
WCB-45	X38C3	N5000	4-3/4	1/2 x 1-1/2 x 2
WCB-146	X38C32	EG18	3	3/8 x 1" x 1-3/4"
WCB-148	21820	FHP N1		.249" x .374" x .859"
WCB-149		H49		1/2" x 1" x 1-1/2"
WCB-150		H45		.492" x 1.26" x 2"
WCB-151		WM56A		.750" x 1.242" x 2"

S.E.E.S. #	O.E.M. #	Grade	Shunt Length	Thick. x W x L
WCB-46	X38E4	WA20B	2	1/4 x 1/2 x 1
WCB-47	X38E13	HRG	3	1/4 x 1/2 x 1
WCB-48	X38E15	W417	2	1/4 x 1/2 x 1
WCB-52	X38E14	WP3	2-1/2	1/2 x 3/4 x 1-1/4
WCB-53	X38E16	N44	2-1/2	1/2 x 3/4 x 1-1/4
WCB-54	X38E17	N44	2-1/2	1/2 x 3/4 x 1-1/4
WCB-49	X38E12	HRG	3	1/4 x 3/4 x 1-1/4
WCB-50	X38E1	N44	3	1/4 x 3/4 x 1-1/4
WCB-51	X38E18	WP3	2-1/2	1/4 x 3/4 x 1-1/4
WCB-141	X38E54	H44	2	1/4 x 3/4 x 1-1/4

■ DIMENSIONS IN INCHES



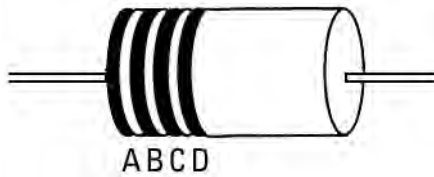

COLOR CODE FOR RESISTOR

COLOR	A	B	C	D
	1st Significant Figure	2nd Significant Figure	Multiplier	% Tolerance
Black	0	0	x1	1
Brown	1	1	x10	2
Red	2	2	x100	3
Orange	3	3	x1,000	4
Yellow	4	4	x10,000	
Green	5	5	x100,000	
Blue	6	6	x1,000,000	
Violet	7	7	x10,000,000	
Gray	8	8	x100,000,000	
White	9	9	x1,000,000,000	
Silver			x0.1	10
Gold			x0.01	5
Missing Band				20

EXAMPLES:

Orange-Green-Red-Silver	$35 \times 10^2 \pm 10\% = 3500 \text{ Ohms}$ @ $\pm 10\%$ tolerance	3150 to 385 Ω
Brown-Black-Orange-Gold	$10 \times 10^3 \pm 5\% = 10,000 \text{ Ohms}$ @ $\pm 5\%$ tolerance	95000 to 1050 Ω
Purple-Yellow-Black-Gold	$74 \pm 5\% = \text{Ohms}$ @ $\pm 5\%$ tolerance	71.5 TO 77.5 Ω
Purple-Yellow-Black	$74 = 20\% = 74 \text{ Ohms}$ @ 20% tolerance	60 to 88 Ω

If the first color band is double width, the resistor is wire wound. Black body indicates a composite non-insulated resistor. Colored body indicates a composite insulated resistor.

*Courtesy of ELEVATOR WORLD, INC., from Elevator Maintenance Manual. Copyright © 1999.
Reprinted by permission.*

Brushes

■ DIMENSIONS IN INCHES

Fig. # 1

S.E.E.S. #	O.E.M. #	Grade	Shunt Length	Thick. x W x L
WCB-55	X38E19	W687	1-1/4	7/32 x 9/32 x 15/16
WCB-57	X38E9	W687	1-1/2	1/4 x 1/2 x 1-1/8
WCB-56	X38E2	X18	1-1/2	1/4 x 1/2 x 1-1/8
WCB-58	X38E6	WL276	2	1/4 x 3/4 x 1-7/16
WCB-59	X38E20	W805	2	1/4 x 3/4 x 1-1/4
WCB-60	X38E22	W128	2	1/4 x 3/4 x 1-1/4
WCB-61	X38E23	W2043	2	1/4 x 3/4 x 1-1/4
WCB-62	X38E24	W2065	2	1/4 x 3/4 x 1-1/4
WCB-63	X38E25	W2064	2	1/4 x 3/4 x 1-1/4
WCB-59A*	X38E21	WP11	2	1/4 x 3/4 x 1-1/4
WCB-64	X38E10	W417	2	1/4 x 3/4 x 1-3/8
WCB-145	X38E52	W75B	2	1/4 x 3/4 x 1-1/4

*No spring

Fig. # 2

S.E.E.S. #	O.E.M. #	Grade	Thick. x W x L
WCB-65	X38F3	W13L	1/2 x 1/4 x 3/16
WCB-66	X38F1	WL317	5/8 x 9/32 x 7/32
WCB-66A	X38F8	N5000	.212 x .275 x .5
WCB-67	X38F4	W805	3/4 x 1/4 x 3/16

Fig. # 3

S.E.E.S. #	O.E.M. #	Grade	Shunt Length	Thick. x W x L
WCB-29	X38G3	WP85	2-1/2	1/2 x 3/4 x 1-1/4

Fig. # 4

WCB-68	X38H5	W13L	1-1/8	3/16 x 1/4 x 9/16
WCB-69	X38H7	W417	1-1/2	1/4 x 1/4 x 3/4
WCB-70	X38H1	WL21	2-1/2	3/16 x 1 x 1

Fig. # 5

WCB-25	X38J3	WL21	1-5/8	3/16 x 1/2 x 7/8
--------	-------	------	-------	------------------

Fig. # 6

WCB-70C	X38K4	W784	4-1/4	3/8 x 1 x 1-1/2
---------	-------	------	-------	-----------------

Fig. # 7

WCB-70A	X38K5	W784	3	3/8 x 1 x 1-3/4
WCB-70B	X38K6	W784	3	1/2 x 1 x 1-3/4
WCB-70D	X38K8	W805	3	3/8 x 1 x 1-3/4
WCB-70F	X38K7	W784	3	1/2 x 1-1/4 x 1-3/4
	X38-K15			
WCB-70G	WEL-99	H22	3	3/8 x 1 x 1-3/4



Fig. # 1: WCB-55 thru WCB-64



Fig. # 2: WCB-65 thru WCB-67



Fig. # 3: WCB-29

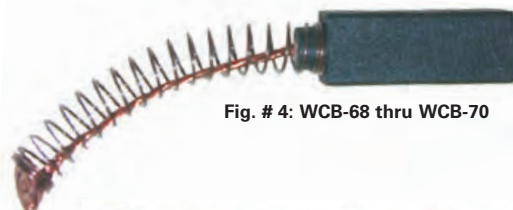

Fig. # 4: WCB-68 thru WCB-70

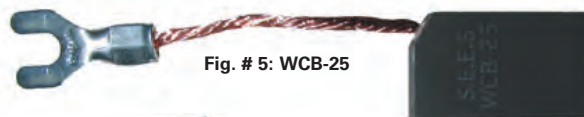

Fig. # 5: WCB-25

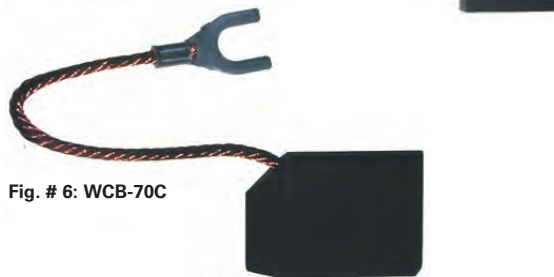
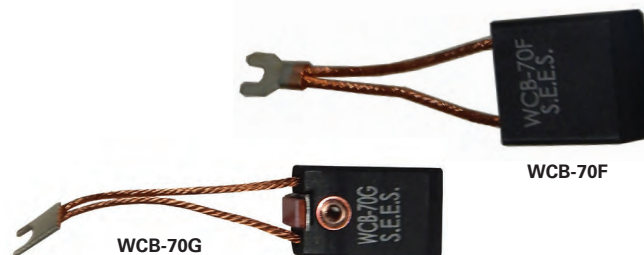

Fig. # 6: WCB-70C



Fig. # 7: WCB-70A thru WCB-70D



WCB-70G

WCB-70F



Brushes

Fig. # 1:
WCB-71 thru WCB-77



Fig. # 2:
WCB-78 thru WCB-89



Fig. # 3: WCB-90, WCB-91

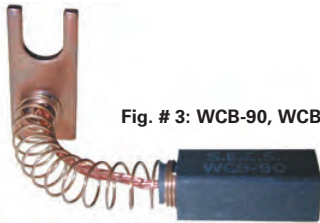

■ DIMENSIONS IN INCHES

FIG. # 1

S.E.E.S. #	O.E.M. #	Grade	Shunt Length	Thick. x W x L
WCB-71	X38L8	W805	3	1/2 x 1 x 1-1/4
WCB-72	X38L1	WP11	3	1/2 x 1 x 1-1/2
WCB-73	X38L2	WP11	3	1/2 x 1-1/2 x 1-1/2
WCB-74	X38L10	W805	3	1/2 x 1-1/2 x 1-1/2
WCB-75	X38L9	W805	3	1/2 x 1-1/2 x 1-3/4
WCB-76	X38L12	W784	3	1/2 x 1-1/2 x 1-3/4
WCB-77	X38L3	WP11	3	1/2 x 1-1/2 x 1-3/4

FIG. # 2

S.E.E.S. #	O.E.M. #	Grade	Shunt Length	Thick. x W x L
WCB-78	X38M3	WP11	3	3/8 x 1 x 1-1/4
WCB-79	X38M9	W805	3	3/8 x 1 x 1-1/4
WCB-80	X38M4	W128	3	3/8 x 1 x 1-1/4
WCB-81	X38M15	W784	3	3/8 x 1 x 1-1/4
WCB-82	X38M17	W2065	3	3/8 x 1 x 1-1/4
WCB-83	X38M16	W784	3	5/16 x 1-1/2 x 1-1/2
WCB-85	X38M10	W805	3	5/16 x 1-1/2 x 1-3/4
WCB-86	X38M20	W784	3	5/16 x 1-1/2 x 1-3/4
WCB-84	X38M12	W805	3	5/16 x 1-1/2 x 1-1/2
WCB-87	X38M19	W784	3	3/8 x 1-1/2 x 1-3/4
WCB-88	X38M11	W805	3	3/8 x 1-1/2 x 1-3/4
WCB-89	X38M13	W805	3	1/2 x 1-1/2 x 1-3/4

Fig. # 4:
WCB-115, WCB-116, WCB-117



Fig. # 5:
WCB-92 thru WCB-114



FIG. # 3

S.E.E.S. #	O.E.M. #	Grade	Shunt Length	Thick. x W x L
WCB-90	X38N1	W805	1-1/8	1/4" x 5/16" x 3/4"
WCB-91	X38N2	WA20B	1-1/8	1/4" x 5/16" x 1"

FIG. # 4

S.E.E.S. #	O.E.M. #	Grade	Shunt Length	Thick. x W x L
WCB-116	X38Q18	W2065	2-3/4	1/2" x 1" x 1-1/4"
WCB-115	X38Q28	W784	2-3/4"	3/8" x 1" x 1-1/4"
WCB-117	X38Q22	W2045	3-1/2"	1/2" x 1" x 1-1/2"

FIG. # 5

S.E.E.S. #	O.E.M. #	Grade	Shunt Length	Thick. x W x L
WCB-92	X38Q1	W510	3-1/2	3/8 x 1 x 1-1/2
WCB-93	X38Q2	W510	3-1/2	1/2 x 1 x 1-1/2
WCB-94	X38Q32	W784	3-1/2	3/8 x 1-1/2 x 1-1/2
WCB-95	X38Q23	W2045	3-1/2	1/2 x 1-1/2 x 1-1/2
WCB-96	X38Q8	W805	3-1/2	1/2 x 1-1/2 x 1-1/2
WCB-97	X38Q3	W510	3-1/2	1/2 x 1-1/2 x 1-1/2
WCB-99	X38Q10	W805	4-1/4	1/2 x 1-1/2 x 1-1/2
WCB-100	X38Q15	W784	4-1/4	1/2 x 1-1/2 x 1-1/2
WCB-101	X38Q14	W784	3-1/2	5/8 x 1-1/2 x 1-1/2
WCB-102	X38Q26	W2045	3-1/2	5/8 x 1-1/2 x 1-1/2
WCB-103	X38Q9	W805	3-1/2	5/8 x 1-1/2 x 1-1/2
WCB-104	X38Q4	W510	3-1/2	5/8 x 1-1/2 x 1-1/2
WCB-107	X38Q11	W805	4-1/4	5/8 x 1-1/2 x 1-3/4
WCB-105	X38Q24	W2045	4-1/4	1/2 x 1-1/2 x 1-3/4
WCB-106	X38Q5	W510	4-1/4	1/2 x 1-1/2 x 1-3/4
WCB-108	X38Q25	W2045	4-1/4	5/8 x 1-1/2 x 1-3/4
WCB-109	X38Q20	W784	4-1/4	5/8 x 1-1/2 x 1-3/4
WCB-110	X38Q6	W510	4-1/4	5/8 x 1-1/2 x 1-3/4
WCB-111	X38Q12	W805	4-1/4	3/4 x 1-1/2 x 1-3/4
WCB-112	X38Q16	W784	4-1/4	3/4 x 1-1/2 x 1-3/4
WCB-114	X38Q19	W784	4-1/4	1 x 1-1/2 x 1-3/4

Brushes

■ DIMENSIONS IN INCHES

Fig. # 1

S.E.E.S. #	O.E.M. #	Grade	Shunt Length	Thick. x W x L
WCB-118	X38R24	W510	2-1/2	3/8 x 5/8 x 1
WCB-119	X38R18	W2008	2-3/4	3/8 x 5/8 x 1-1/4
WCB-123	X38R1	W510	2-3/4	3/8 x 1 x 1-1/4
WCB-124	X38R2	W805	2-3/4	3/8 x 1 x 1-1/4
WCB-125	X38R10	W2045	2-3/4	3/8 x 1 x 1-1/4
WCB-126	X38R6	W784	2-3/4	3/8 x 1 x 1-1/4
WCB-122	X38R19	W510	2-3/4	1/2 x 5/8 x 1-1/4
WCB-127	X38R3	W805	2-3/4	1/2 x 1 x 1-1/4
WCB-128	X38R15	W2045	3-1/2	1/2 x 1 x 1-1/2



Fig. # 1:
WCB-118 thru WCB-119 & WCB-123 thru WCB-128



Fig. # 2:
WCB-120, and WCB-129 thru WCB-136A

Fig. # 2

S.E.E.S. #	O.E.M. #	Grade	Shunt Length	Thick. x W x L
WCB-120	X38R14	W2045	2-3/4	3/8 x 5/8 x 1-1/4
WCB-121	X38R22	W510	2-3/4	3/8 x 5/8 x 1-1/4
WCB-129	X38R21	W2045	3-1/2	3/8 x 1 x 1-1/2
WCB-133	X38R17	W2008	3-1/2	1/2 x 1-1/2 x 1-1/2
WCB-134	X38R12	W2045	3-1/2	1/2 x 1-1/2 x 1-1/2
WCB-130	X38R16	W2008	3-1/2	3/8 x 1-1/2 x 1-1/2
WCB-131	X38R11	W2045	3-1/2	3/8 x 1-1/2 x 1-1/2
WCB-132	X38R4	W510	3-1/2	3/8 x 1-1/2 x 1-1/2
WCB-135	X38R5	W510	3-1/2	1/2 x 1-1/2 x 1-1/2
WCB-136	X38R23	W2008	3-1/2	5/8 x 1-1/2 x 1-1/2
WCB-136A	X38R13	W2045	3-1/2	5/8 x 1-1/2 x 1-1/2



WCB-121



WCB-131



Fig. # 3: WCB-137

Fig. # 3

S.E.E.S. #	O.E.M. #	Grade	Shunt Length	Thick. x W x L
WCB-137	X38T1	W687	1-5/8	3/16 x 1/4 x 1

Fig. # 4

S.E.E.S. #	O.E.M. #	Description	Thick. x W x L
WCB-138	569A803H02	For Tach Generator	3/16 x 9/16



Fig. # 4: WCB-138

Fig. # 5

S.E.E.S. #	O.E.M. #	Grade	Shunt Length	Thick. x W x L
WCB-2A	229610	255	3-7/8	3/8 x 3/4 x 1-1/2
WCB-2B	222319	255	3-7/8	3/8 x 1 x 1-3/4



Fig. # 5: WCB-2A, WCB-2B

S.E.E.S. #	O.E.M. #	Description
WCB-143	BHC249	Brush Caps for WDO-61J, set of 4
WCB-144		Brush Cap for WDO-61G
WCB-147	X38ABS2H30	Carbon brush, 5/16" x 1-1/4" x 2"



WCB-143



WCB-144

Brush Holders



WBH-04



WBH-05



WBH-011



WBH-012



WBH-D01



WBH-D05

For SKH Motors Constant Pressure Style

S.E.E.S. #	O.E.M. #	Rod	Brush holder		No. of Brushes
			Width	Thick	
WBH-01	4110D65G01	1/2"	5/8"	3/8"	1
WBH-02	4110D65G02	1/2"	5/8"	1/2"	1
WBH-03	4110D65G03	1/2"	5/8"	3/8"	1
	556D008G01				
WBH-04	4110D65G04	1/2"	5/8"	1/2"	1
	556D008G02				
WBH-05	4110D65G05	1/2"	1"	3/8"	1
	556D008G13				
WBH-06	4110D65G06	1/2"	1"	1/2"	1
WBH-07	4110D65G07	3/4"	1"	3/8"	1
WBH-08	4110D65G08	3/4"	1"	1/2"	1
WBH-09	4110D65G09	3/4"	1"	5/8"	1
WBH-010	4110D65G10	3/4"	1"	1"	1
WBH-011	4110D65G11	3/4"	1-1/2"	3/8"	1
WBH-012	4110D65G12	3/4"	1-1/2"	1/2"	1
WBH-016	4110D65G16	1"	1-1/2"	5/8"	1
WBH-019	4110D65G19	1"	1-1/2"	1-1/4"	1

For SKH Motors Fingerstyle

S.E.E.S. #	O.E.M. #	Rod	Brush holder		No. of Brushes
			Width	Thick	
WBH-D01	556D008G19	1/2"	1"	1/4"	2
WBH-D02	556D008G05	3/4"	1"	1/4"	2
WBH-D03	556D008G06	3/4"	1"	5/16"	2
WBH-D04	556D008G07	3/4"	1"	3/8"	2
WBH-D05	556D008G09	3/4"	1-1/2"	1/2"	2
WBH-D06	556D008G11	3/4"	1-1/2"	5/16"	2
WBH-D07	556D008G12	3/4"	1-1/2"	3/8"	2
WBH-D09	556D008G16	1"	1-1/2"	5/16"	2
WBH-D10	556D008G17	1"	1-1/2"	3/8"	2
WBH-D11	556D008G18	1"	1-1/2"	1/2"	2
WBH-D12	556D008G20	1"	1-1/2"	5/8"	2
WBH-D13	4110D65G13	3/4"	1-1/2"	5/8"	1
WBH-D14	4110D65G14	3/4"	1-1/2"	3/4"	1
WBH-020	556D008G03	3/4"	1"	3/8"	1
WBH-021	556D008G04	3/4"	1"	1/2"	1
WBH-022	556D008G10	3/4"	1-1/2"	1/2"	1
WBH-023	556D203G01	1/2"	5/8"	3/8"	1
WBH-024	556D203G02	1/2"	5/8"	1/2"	1

Replacement Spring Clips

Brush Holders

S.E.E.S. #	Description
WBH-1A	Spring Clip 1" W x 2-1/2" OL, for WBH-011*
WBH-2A	Spring Clip 5/8" W x 2" OL, for WBH-05*
WBH-5A	Spring Assembly for holder 4110D65H03
WBH-03A	Spring Clip 1/2" W x 2" OL, for WBH-03*
WBH-07A	Spring Clip 5/8" W x 2-3/8" OL, for WBH-07*

*Clips can be used on other holders as well. Additional clips available, inquire with your requirements.

S.E.E.S. #	O.E.M. #	Description
WBH-3	694B476G01	Exciter Brush Holder brush box 3/4" x 1/4"
WBH-3A		Male cap for exciter brush
WBH-4	321C333G01 630B317H01	Double Brush Holder brush box 3/8" x 2" wide



WBH-1A



WBH-03A



WBH-07A



WBH-3



WBH-4



WCC-1



WCC-4



WCC-4A



WCC-5



WCC-6



WCC-8

Carbon and Graphite Contacts

S.E.E.S. #	O.E.M. #	Description
WCC-1	T441H20	1-1/4" x 1-1/2" x 1" Square Carbon Contact
WCC-2	T441H16	1-1/4" x 1-1/2" x 1" Square Metal Graphite
WCC-3		1-1/2" x 1-1/2" x 2" Square Carbon Contact
WCC-4	K4495H01	5/8" x 5/8" x 3/4" Square Carbon Contact with 9/64" hole for 6-32 screw
WCC-4A	61000274	5/8" x 5/8" x 3/4" Square Metal Graphite with 9/64" hole
WCC-5	K179H01	5/8" x 5/8" x 3/4" Square Metal Graphite with 3/16" hole for 10-32 screw
WCC-6	P1534H10	1" x 1" x 3/4" Square Carbon Contact
WCC-7	P1534H02	1" x 1" x 3/4" Square Metal Graphite Contact
WCC-8	K1177G01	1/2" x 1/2" Metal Graphite Contact

Coils



Fig. #1: WC-86

 Fig. #2:
WC-56 thru
WC-59

Fig. #4: WC-63, WC-64

 Fig. #3:
WC-60 thru
WC-62

Fig. #5: WC-87

 Fig. #7:
WC-18 thru WC-27A

 Fig. #6: WC-87A,
WC-88, WC-89

 Fig. #8:
WC-1 thru WC-171

1-9/16" ID x 2-3/4" OD x 4-1/16" L

S.E.E.S. #	O.E.M. #	Resistance	Fig. #
WC-86	696668	330	1

8/32 Thread ID x 1-7/16" OD x 2-1/2" L

S.E.E.S. #	O.E.M. #	Volts	Resistance	Fig. #
WC-56	K5801G01	125	2900	2
WC-57	K5801G02	62.5	504	2
WC-58	K5801G03	62.5	714	2
WC-59	K5801G04	125	2180	2

8/32 Thread ID x 1-7/16" OD x 2-1/2" L

S.E.E.S. #	O.E.M. #	Volts	Resistance	Fig. #
WC-60	K5802G01	125	A-2010, B-1330	3
WC-61	K5802G02	125	A-1815, B-765	3
WC-62	K5802G03	48	A-8210, B-1650	3

■ A = Inner winding resistance B = Outer winding resistance

S.E.E.S. #	O.E.M. #	Volts	Resistance	Fig. #
WC-63	K6738G01	125	1800	4
WC-64	K6738G02	48	450	4

1-17/64" ID x 2-49/64" OD x 3-43/64" L

S.E.E.S. #	O.E.M. #	Volts/Amps	Resistance	Fig. #
WC-87*	R9822G03	50A	.2	5
WC-87A	R9822G04	125V	582	6
WC-88	R9822G05	230V	1910	6
WC-89	R9822G06	125V	354	6

* 1" ID x 2-7/8" OD

8/32 Thread ID x 1-7/16" OD x 2-1/2" L

S.E.E.S. #	O.E.M. #	Volts	Resistance	Fig. #
WC-18	X19BG01	48	205	7
WC-19	X19BG02	190	2820	7
WC-20	X19BG03	94	810	7
WC-21	X19BG04	62.5	637	7
WC-22	X19BG05	24	53	7
WC-23	X19BG06	200	3300	7
WC-24	X19BG07	120	1200	7
WC-25	X19BG08	125	3840	7
WC-27	X19BG11		2400	7
WC-26	X19BG09		1860	7
WC-27A	X19BG14		994	7

17/32" ID x 1-5/8" OD x 2-3/4" L

S.E.E.S. #	O.E.M. #	Volts	Resistance	Fig. #
WC-1	X19BBG01	230	3300	8
WC-2	X19BBG02	125	987	8
WC-3*	X19BBG03		1625	8
WC-4	X19BBG04		2900	8
WC-5	X19BBG05		2180	8
WC-6	X19BBG06	125	1755	8
WC-7	X19BBG07	62.5	430	8
WC-9	X19BBG09		714	8
WC-10	X19BBG10	125	1720	8
WC-11	X19BBG11	125	1240	8
WC-13	X19BBG13	62.5	324	8
WC-14	X19BBG14	125	1235	8
WC-15	X19BBG15	125	1090	8
WC-16	X19BBG16	125	1800	8
WC-17	X19BBG17	62.5	275	8
WC-17A	X19BBG18	230	4510	8
WC-17B	X19BBG19	48	178	8
WC-17C	X19BBG20	48	197	8
WC-17D	X19BBG21	230	4160	8
WC-17E	X19BBG22	125	1090	8
WC-17F	X19BBG23		1790	8
WC-17G	X19BBG24		1800	8
WC-17H	X19BBG25		4510	8
WC-17I	X19BBG26		0.09	8

* 21/64" ID x 1-1/16" OD x 15/16" L

Coils

S.E.E.S. #	O.E.M. #	Volts	Resis.	ID x OD x L
WC-28*	X19CAG01, X19BGG01, X19BGG09, X19BGG17, X19BGG20	125	2870	7/16" x 1-5/32" x 2-3/8"
WC-29*	X19CAG02, X19BGG02, X19BGG10, X19BGG18, X19BGG21	62.5	810	7/16" x 1-5/32" x 2-3/8"
WC-30	X19CAG03, X19BGG03, X19BGG11	25	5700	7/16" x 1-5/32" x 2-3/8"
WC-31	X19CAG04, X19BGG04, X19BGG12	125	1725	25/32" x 1-5/32" x 2-3/8"
WC-32	X19CAG05, X19BGG05, X19BGG13	64	794	7/16" x 1-5/32" x 2-3/8"
WC-33*	X19CAG06, X19BGG06, X19BGG14	62.5	425	7/16" x 1-5/32" x 2-3/8"
WC-34	X19CAG07, X19BGG07, X19BGG15	125	8334	7/16" x 1-5/32" x 2-3/8"
WC-35	X19CAG08, X19BGG08, X19BGG16	21	155	7/16" x 1-5/32" x 2-3/8"

*Used on ES Relays



WC-28



WC-29



WC-31



WC-40



WC-90

WC-92

WC-93

WC-100

S.E.E.S. #	O.E.M. #	Resistance/Description	ID x OD x L
WC-90	X19BCG01	557	29/32" x 2-3/4" x 4-3/8"
WC-92	X19FS1G03	Inductor coil, 125V, 311 ohm	29/32" x 2-3/4" x 4-3/8"
WC-93	M1663G10	Brake coil 115V, 85 ohm	3" x 5.5" x 8.5"
WC-94	X19PS1G05	Esc Brake Coil 120V, 4,000 ohm	
WC-100	X19ZG11	1630 / Rotodial coil 125V	3/4" x 1-1/16" x 1"

S.E.E.S. #	O.E.M. #	Volts	Resistance	ID x OD x L
WC-40	X19BHS1G01, X19BHG10, X19CBG01, X19BH-GR1	125	A-2295, B-917	29/64" x 1-3/16" x 2-3/8"

■ A = Inner winding resistance B = Outer winding resistance.

S.E.E.S. #	O.E.M. #	Volts	Resis.	ID x OD x L
WC-41	X19BJG01, X19CCG01	125	2030	21/32" x 1-7/16" x 2-15/32"
WC-42	X19BJG02, X19CCG02	62.5	545	21/32" x 1-7/16" x 2-15/32"
WC-43	X19BJG03, X19CCG03	230	7322	21/32" x 1-7/16" x 2-15/32"

S.E.E.S. #	O.E.M. #	Volts	Resis.	Size	ID x OD x L
WC-43B	X19BKG01	125	18	1	1-25/32" x 4" x 3-1/4"
WC-43A	X19BKG02	125	1100	2	25/32" x 2-1/4" x 2-9/16"

S.E.E.S. #	O.E.M. #	Volts	Resistance	ID x OD x L
WC-82	X19BVG01	230	32.4	21/64" x 1" x 31/32"
WC-83	X19BVG02	115	0.73	21/64" x 1" x 31/32"

S.E.E.S. #	O.E.M. #	Volts	Resistance	ID x OD x L
WC-67	X19EG19	125	918	5/8" x 1-5/8" x 2-3/4"
WC-68	X19EG22	125	13310	5/8" x 1-3/4" x 3-3/16"
WC-70	X19EG25	125	727	1" x 1-3/4" x 3-3/16"



WC-41, WC-42, WC-43



WC-43B, WC-43A

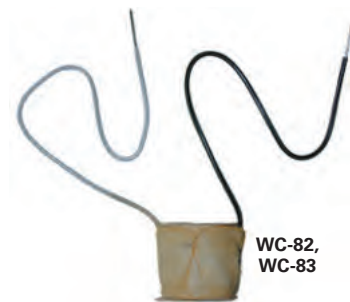

WC-82, WC-83



WC-67 thru WC-70



Coils

Starter Coils

13/32" ID x 1-5/16" OD x 2-5/32" L

S.E.E.S. #	O.E.M. #	Description	Volts
WC-79	505C806G02	Size 2, 60 cycle	208-220
WC-79A	505C633G02	Size 3 & 4, 60 cycle	208-220
WC-79C	506C143G02 1268C86G02	Size 2, DC	125
WC-79D	506C428G01 1255C68G01	Size 3 & 4	125 VDC

5-3/8" OD x 7-1/2" L

S.E.E.S. #	O.E.M. #	Description	Volts
WC-84	X19PS1G01	Brake coil, 117 Ohm	125 VDC

4-3/8" OD x 5-1/4" L

S.E.E.S. #	O.E.M. #	Description	Volts
WC-85	X19PS1G08	Brake coil, 113 Ohm	120 VDC

2-15/16" ID x 5-1/2" OD x 8-3/8" L

S.E.E.S. #	O.E.M. #	Description	Volts
WC-85A	M1663G10	Brake coil, 85 Ohm, West #57 machine	120 VDC



WC-79, WC-79A,
WC-79C, WC-79D



WC-84

13/32" ID x 1-5/16" OD x 2-5/32" L

S.E.E.S. #	O.E.M. #	Volts	Resistance
WC-49	X19GG01	240	4250
WC-50	X19GG02	120	1060
WC-51	X19GG03	300	6250
WC-52	X19GG04	48	166
WC-53	X19GG05	68	410
WC-54	X19GG06	120	272
WC-55	X19GG07	157	1920



WC-49 thru
WC-55



WC-44 thru WC-48



WC-80, WC-81



WC-71 thru
WC-78



WC-66

15/16" ID x 2-5/8" OD x 2-3/8" L

S.E.E.S. #	O.E.M. #	Volts	Resistance
WC-65	X19KG12	50	125

15/16" ID x 2-11/16" OD x 3-1/16" L

S.E.E.S. #	O.E.M. #	Volts	Resistance
WC-65B	X19KG15	95	318

15/16" ID x 2-5/8" OD x 2-7/16" L

S.E.E.S. #	O.E.M. #	Volts	Resistance
WC-65C	X19KG16	105	318



WC-65,
WC-65B, WC-65C

13/32" ID x 1-5/16" OD x 2-5/32" L

S.E.E.S. #	O.E.M. #	Volts	Resistance
WC-44	X19HG01	240	A-3900, B-467
WC-45	X19HG02	120	A-990, B-467
WC-46	X19HG03	300	A-5800, B-690
WC-47	X19HG04	48	A-13, B-3
WC-48	X19HG05	16	A-20, B-3

13/32" ID x 1-5/16" OD x 2-5/32" L

S.E.E.S. #	O.E.M. #	Volts	Resistance
WC-80	X19NG10	125	405
WC-81	X19NG11	230	1000

13/32" ID x 1-5/16" OD x 2-5/32" L

S.E.E.S. #	O.E.M. #	Resistance
WC-71	X19YG01	5790
WC-73	X19YG03	104
WC-74	X19YG04	1.8
WC-75	X19YG05	0.0066
WC-76	X19YG06	0.0166
WC-77	X19YG07	0.0025
WC-78	X19YG08	4.4

13/32" ID x 1-5/16" OD x 2-5/32" L

S.E.E.S. #	O.E.M. #	Volts	Resistance
WC-66	K52401	125 VDC	583

Door Parts and Equipment

FOR SCHINDLER/WESTINGHOUSE

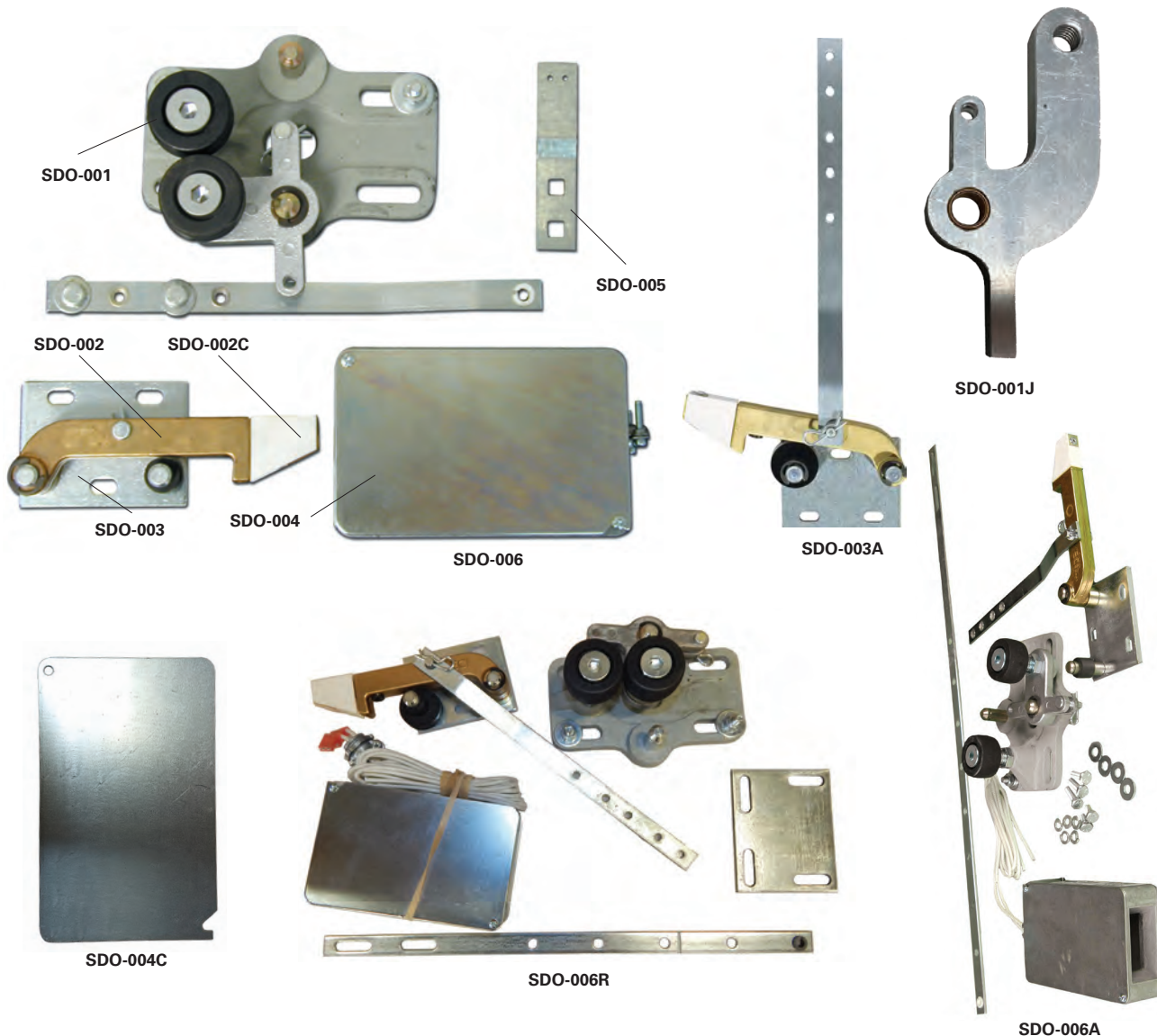

S.E.E.S. #	O.E.M. #	Description
SDO-001	5226D09H20	Universal Pick-Up Roller Base Assembly
SDO-001J		Actuator Assembly
SDO-001T		Pivot Arm, T-Section for Pick Up Assembly
SDO-002	5226D09H11	Interlock Hook, Hook assembly with nose piece
SDO-002C	890-3037	Nose Contact Assembly, Replacement
SDO-003		Bracket, universal, 3-1/4" L x 2-1/2" W x .20" H
SDO-003A	890-3013	Beak Assembly, Hook and Bracket Complete, LH or RH
SDO-004	5226D09H15	Interlock Box Assembly, with contacts
SDO-004C		Cover only for SDO-004 Interlock
SDO-005		Bracket for Spirator, 4-3/4" L x 1" W x .10" H
SDO-006		Door Interlock Kit, 27" LH, includes SDO-007, SDO-009, SDO-012, SDO-015, SDO-016, SDO-17 and SDO-018
SDO-006A	5226D09H03	Door Interlock Kit, 27" RH, includes SDO-009, SDO-010, SDO-012, SDO-015, SDO-016, SDO-017 and SDO-018
SDO-006R	890-3000-1R 5226D09H01	Interlock Assembly, "A" link, center parting, 33"- 39" RH

Door Parts and Equipment



S.E.E.S. #	O.E.M. #	Description
SDO-008	5226D09H18	Pick-Up Roller Assembly , for SDO-001, with shaft and hardware
SDO-008B	611010220	Roller/Axle Assembly , 30mm x 10mm for Schindler QKS9, D30
SDO-008S		Shaft , for Pickup Roller, Shaft Size from End to End 2 1/4"
SDO-008W	5226D09H18	Chain Tension Roller , White Includes Ret. Ring and Speed Nut
SDO-009	5226D09H12	Linkage Arm Kit , off set, for 15-1/2" & 27" assemblies
SDO-011	5226D09H19	Screw , roller stem
SDO-012	5226D09H09	Bumper , beak plate
SDO-013	5226D09H14	Collar Bushing , back plate
SDO-014	890-3004	Contact Block , interlock box
SDO-015	896-2002	Hitch Pin Clip , for beak assembly
SDO-016	896-2005	Nyliner Bushing , for beak assembly
SDO-017	896-1012	Hitch Pin , for beak assembly
SDO-018	890-3011	EXT "C" Ring Clip , for beak assembly
SDO-019	895-3014	Chain Tension Assembly , QKS-14 door operator
SDO-020	895-3012	Motor Sprocket , QKS-14 door operator, 15 teeth
SDO-20A	895-3013	Operator Chain , for QKS-14 57" Long, 3/8" Pitch
SDO-021	895-3007	Motor Belt Pulley , QKS-14 door operator (small one)
SDO-022	895-3008	Motor Belt Pulley , QKS-14 door operator (large one)
MDO-1	5207D42H46	V-Belt , 4L550 (EZ/QKS-14/15 door operator)
SDO-027A	KBMA-24D	Drive , AC, 1HP, 240V, 3.6A
SDO-028	692B997H03	Encoder , optical 47PPR, 5 VDC
SDO-029	692B997H04	Encoder , optical 104PPR, ACVF



Door Parts and Equipment

S.E.E.S. #	O.E.M. #	Description
SDO-030L	894-3001-1L	Gate Switch Assembly , for Schindler, Left hand
SDO-030R	894-3001-1R	Gate Switch Assembly , for Schindler, Right hand
SDO-031	894-3004	Movable Contact , for Schindler gate switch
SDO-032	894-3006	Stationary Contact , for Schindler gate switch
SDO-051	693B440H02	Drive Pulley , for QKS-16 Door Operator
SDO-052	7269C23H03	Pulley, Sheave , for Telescopic Jack 330A
SDO-18	6994C01G01	Slotted "C" Linkage Assembly
SDO-186	1000-3026	Slotted "C" Linkage Assembly
SDO-187	1000-3025	Tapped "C" Linkage Assembly



SDO-031



SDO-052



SDO-032



SDO-030L



SDO-030R



SDO-186

S.E.E.S. #	O.E.M. #	Description
WDO-61G	692B863G01,	Door Operator Motor , 1/6 HP, 1150 RPM, 170 VDC, permanent magnet, flange mount
WDO-61H	7283C05H02	Door Operator Motor , 1/3 HP, 1725 RPM, 180 VDC, permanent magnet WDO-61HA Pulley, for WDO-61H
WDO-61HA	5203D67H08	Pulley , for WDO-61H door operator motor
WDO-61J	7285C56H01	Door Motor , QKS-14 1/6 HP, 1140 RPM 170 VDC foot mounting
MDO-1	5207D42H46	V-Belt , 4L550 (EZ/QKS-14/15 door operator)
WCB-55A		Carbon Brush , 1/4" x 3/8" x 1/2" with 7/8" long spring for WDO-61J



WDO-61G



WDO-61HA



WDO-61J



WCB-55A

Controller Equipment

S.E.E.S. #	O.E.M. #	Description
SPR-001	1320B08H01	Three Phase Voltage Monitor , 208-240 VAC
SPR-002	1320B08H02	Three Phase Voltage Monitor , 400-480 VAC
SPR-003	7264C46H01	Power Supply , plug in 5 VDC



SPR-001



SPR-003

Door Parts and Equipment



WDO-1



WDO-2



WDO-4



WDO-4A



WDO-5



WDO-6



WDO-7

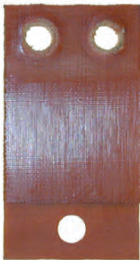

WDO-8



WDO-9

Type B2 Interlocks

S.E.E.S. #	O.E.M. #	Description
WDO-1		Base for Contact
WDO-2	R3620G03	Contact Assembly, "make"
WDO-3	R3620G04	Contact Assembly, "break"
WDO-3A	R3620G01	Contact and Base Assembly, complete with 2 "make" contacts
WDO-4	K7028H01, K3244G01	Roller Arm assembly complete
WDO-4A		Bolt for WDO-4A assembly
WDO-5	K7028H01	Arm, alone for WDO-4 assembly
WDO-6	K3244G01	Roller, alone for WDO-4 assembly, 1-1/2" OD, 3/8" ID, 1/4" Thickness, 1/2" overall, rubber
WDO-7	K5957H02, R6952H10	Complete Block contact bridge assembly, includes WDO-8 and WDO-9
WDO-8	K5957H02	Bridging Block, alone
WDO-9	R6952H10	Contact Bridge
WDO-10	145A765H01	Latch Insulator



WDO-10



WDO-20



WDO-21

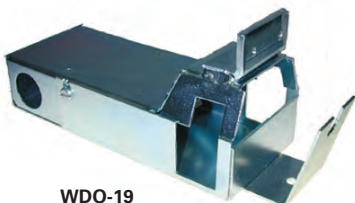

WDO-19

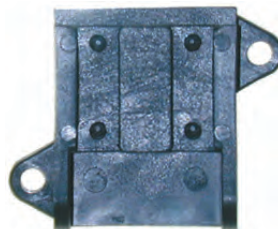

WDO-22

Types E, E1 Interlocks

S.E.E.S. #	O.E.M. #	Description
WDO-19	465D864G01	Interlock assembly
WDO-20		Support for contact WDO-21
WDO-21	144A568G01	Finger Contact with silver tip
WDO-22	215B687H01	Base for stationary contact

Door Parts and Equipment



Types E and E1 Interlocks

S.E.E.S. #	O.E.M. #	Description
WDO-11	576B812H01	Nylon Drive Block, for E1, 3-3/4" L
WDO-12	630B424H01	Nylon Drive Block, for E1 and E5
WDO-13	151B776H01	Short Drive Block with retractable vane, 3-7/8" L, for E1
WDO-14	151B671H01	Long Drive Block with stationary vane, 4-9/32" L, for E1

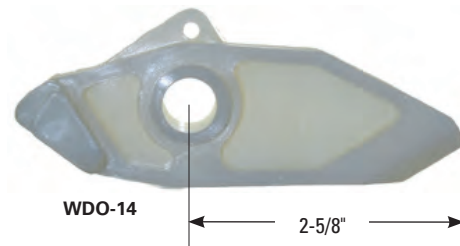

S.E.E.S. #	O.E.M. #	Description
WDO-16	X9JS1H18	Spring for latch arm
WDO-17	X14BS1H04	Rubber Bumper for type E
WDO-18	X14BS1H05	Rubber Sleeve for type E
WDO-24	324C463G06	Complete Latch Lever, LH for E1 Interlock
WDO-25	324C463G05	Complete Latch Lever, RH for E1 Interlock
WDO-26	144A563H02	Complete Latch Lever, LH for E Interlock
WDO-27	144A563H01	Complete Latch Lever, RH for E Interlock
WDO-28	576B807G01	Contact Bridge, for latch lever, Type E1
WDO-29	144A520G01	Contact Bridge, for latch lever, Type E
SCRP-1		Rubber Cushion, 40/37mm x 45mm ID: 20mm



WDO-29

SCRP-1

Door Parts and Equipment



WDO-12



WDO-49



WDO-48



WDO-52

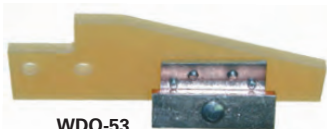

WDO-53



WDO-53A



WDO-53C



WDO-53D



WDO-53E



WDO-53G



Type E5 and E5A Interlocks

S.E.E.S. #	O.E.M. #	Description
WDO-12	630B424H01	Nylon Drive Block, 3-9/16"
WDO-48	196C527G01	Interlock Complete Assembly, E5 and E5A, RH or LH
WDO-48D		Cover alone for interlock
WDO-49	682A227G01	Contact Blade with silver tip
WDO-52	864A963H01	Separator/Insulator
WDO-53	682A244H01	Nose and Contact Assembly, RH (shown)
WDO-53A	5194D85G01	Complete Drive Block Assembly Complete, RH (shown)
WDO-53B	5194D85G02	Complete Drive Block Assembly Complete, LH
WDO-53C	5212D87G05	Interlock Assembly, RH, includes WDO-53A + WDO-48
WDO-53D	5212D87G01	Interlock Assembly, LH, includes WDO-53B + WDO-48
WDO-53E	5212D87G05	Interlock A Kit, WDO-53A & WDO-48 & WDO-53G
WDO-53F	5212D87G01	Interlock A Kit, WDO-53B & WDO-48 & WDO-53G
WDO-53G		Interlock A Hardware kit shims and bolts
WDO-54	682A245G01	Nose and Contact Assembly, LH
WDO-56	X9KS1H02	Spring to WDO-53A 7/16" ID x 1-7/8" long
WDO-56A		Spring
WDO-56B	865A388H01	Spring, loop 4-1/8" long
WDO-66	X9FS1H07	Spring



WDO-56



WDO-56A



WDO-66

Door Parts and Equipment

Drive Block – Polyurethane

S.E.E.S. #	O.E.M. #	A	B
WDO-30	M3393H01	1"	5-1/2"
WDO-31	M3639H01	1"	8"
WDO-32	R9314H01	1-5/8"	10"
WDO-32A	M6845H01	1-5/8"	8"

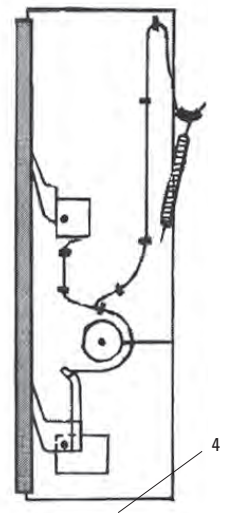
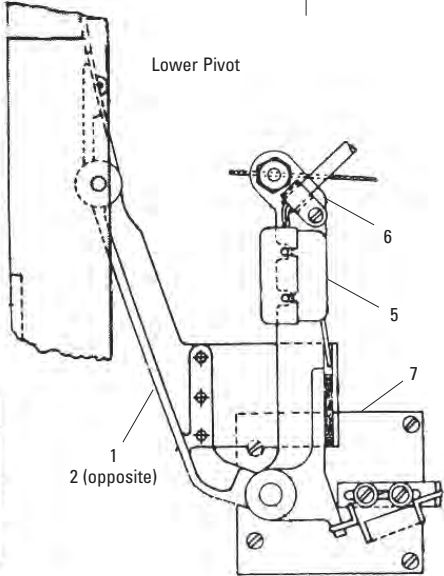
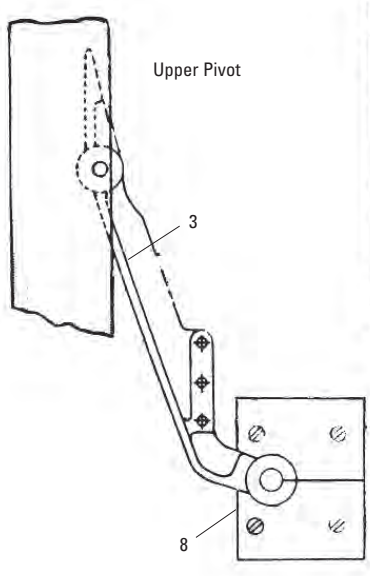
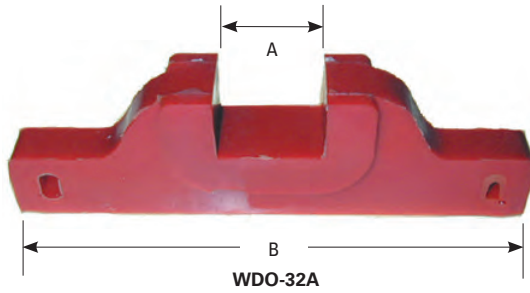
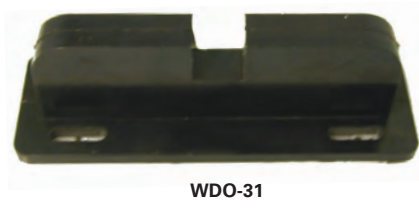
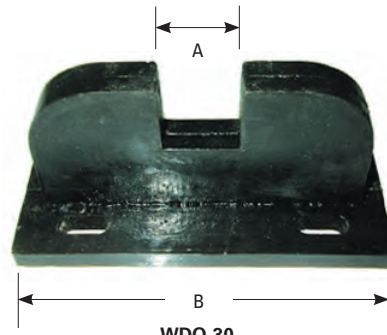

Detail for E and BB2 Operators



Safety Edge Type SE3

Fig.	S.E.E.S. #	O.E.M. #	Description
1	WDO-35C	465D041G01	Lower Pivot Arm Assembly, LH
2	WDO-35D	465D041G02	Lower Pivot Arm Assembly, RH
3	WDO-35F	320C901G01	Upper Pivot Arm Assembly, RH & LH
4	WDO-35	320C905G01	Safety Edge Retracting Unit, 5-1/2" OD
5	WDO-62	144A026H03	Micro Switch
6	WDO-35E	320C902G01	Retractor Arm, Reversible RH & LH
7	WDO-35A	215B305G01	Lower Pivot Bracket
8	WDO-35B	215B306G01	Upper Pivot Bracket

Door Parts and Equipment



WDO-34



WDO-34A



WDO-34B



WDO-41



WDO-42



WDO-40

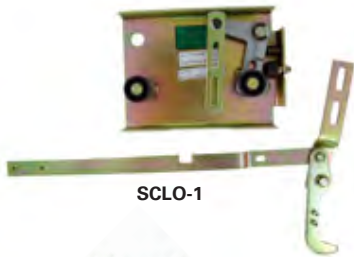

SCLO-1



WDO-43



WDO-44



WDO-45



WDO-46



SCLO-4



SCLO-9



SCLO-10



SCLO-10A



SCDV-1

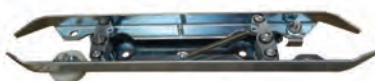

SCDV-2



WDO-48A

WDO-48B



WDO-48C

S.E.E.S. #	O.E.M. #	Description
MIS-124		Spirator , reel, 5" OD with combo hub
WDO-34	576B615H01	Spirator , closing reel 6" diameter with cable
WDO-34A		Bracket and Hardware , for WDO-34 or MIS-124
WDO-34B	811C418G01	Kit , Spirator (MIS-124) and Hardware (WDO-34A)

■ Two locating holes in spirator plastic center bushing.

S.E.E.S. #	O.E.M. #	Description
WDO-40	K3802G01	Movable Contact , 4-1/2" L
WDO-40A	K3188G01	Movable Contact , 5-3/4" L
WDO-41	R7512G01	Stationary Contact , tip 1/4" diameter
WDO-42		Square Cable Stud Clamp Bolt , 3/4", 1/2-20 threaded
WDO-43		Cable Stud Eye Clamp , 3/4" diameter, 1/2-20 threaded
WDO-44	K32682	Cable Stud Eye Clamp , 3/4" diameter, 3/8-16 threaded
WDO-45	R80263	Cable Stud Pin , 1/2" diameter, 3/8-16 threaded
WDO-46	R80261	Square Clamp Bolt Stud , 3/4" diameter, 3/8-16 thread

SCLO-1	Z134148	Lock , for Door QKS9(PB260) 1 left + 1 right
SCLO-4		Lock , for Door AD9
SCLO-9		Opening Device
SCLO-10		Contact , for PB16D Door Lock Goods Lift
SCLO-10A		Contact , Door Lock PB16D (Double Prong)
SLS-1	418482	Level Switch , MSR B1 C, 41 8 482/481

SCDV-1		Door Vane , for PB51
SCDV-2		Door Vane , for V30

S.E.E.S. #	O.E.M. #	Description
WDO-48A	197C534H01	Bracket Double Bend
WDO-48B	197C567H01	Bracket Single Bend
WDO-48C	197C534H03	Bracket Triple Bend

Oil Can

S.E.E.S. #	Description
SCOC-1	Oil Can , for Schindler Elevator

Door Parts and Equipment

S.E.E.S. #	O.E.M. #	Description
WDO-57	569A884H01	Lunar Key , 6" long, stainless steel
WDO-58	W-824T	T-Key used for interlock, 9" long
WDO-58E	W-824T-E	T-Key , Extended 15" OAL
WDO-57A		Escutcheon Plate for lunar key, S.S., self-adhesive
WDO-57B		Escutcheon Plate for "T" key, 7/8" face nickel finish with locking push nut
WDO-57AB		Escutcheon , bronze lunar 1-1/2" OD
WDO-49	682A227G01	Contact Blade with silver tip
WDO-50	682A302H01	Contact Blade support
WDO-51	682A226H01	Base for stationary contacts, for type "E5" interlock
WDO-57C		Escutcheon , Door Sleeve for lunar key



WDO-51



WDO-57C



SCDS-1



WDO-57



WDO-58



WDO-57A



WDO-57B



WDO-49



WDO-50



SCDS-2



SCDS-3



SCDS-4



WDO-59A

S.E.E.S. #	Description
SCDS-1	Door Gib
SCDS-2	Door Gib
SCDS-2C	Door Gib , for Schindler with Iron
SCDS-3	Door Gib , for 300P 22mm x 18mm x 11mm
SCDS-4	Door Gib , Rubber
SCDS-5	Plastic Door Slide

Door Gib Assemblies

S.E.E.S. #	O.E.M. #	Description
WDO-59	146A746H01	Nylon Gib Refill for WDO-59B and C, 4" long x 15/32" wide
WDO-59A		Offset Door Gib with 1/2" offset 3-1/2" long
WDO-59A-K	691B971H01	Gib Kit , WDO-59A + WDO-59 1/2" Offset Brkt with Nylon Gib
WDO-59B	576B681H01	Solid Gib Bracket , 4" long x 2-1/2" wide, with 1/16" offset, uses gib WDO-59
WDO-59B-K		Gib Kit , WDO-59B + WDO-59
WDO-59C	691B971H01	Solid Gib Bracket , 4" long x 2-1/2" wide, straight, no offset, uses gib WDO-59
WDO-59C-K	691B971H01	Kit (WDO-59C and WDO-59)
WDO-59C-SS	691B971H01	Gib Bracket Straight 304SS 4" L x 2-1/2" Wide, stainless steel
WDO-59C-SS-K		Kit , WDO-59C-SS and WDO-59 Bracket and Gib, stainless steel
WDO-59D	691B971H05	Offset Gib Bracket , 1/4" x 4" long
WDO-59D-K	691B971H01	Gib Kit , WDO-59D + WDO-59 1/4" Offset Brkt with Nylon Gib
WDO-59E	576B68H01	Offset Gib Bracket , 5/16" x 4" long Type 1 Offset
WDO-59E-K		Gib Kit , WDO-59E + WDO-59 5/16" Offset Brkt with Nylon Gib
WDO-59F		Door Gib , .66" W slot x 7.03" L
WDO-59G		Solid Gib Bracket , 1/8" Offset 3-1/2" Lg with Gib Insert & hdw



WDO-59F



WDO-59A-K



WDO-59B



WDO-59B-K



WDO-59C



WDO-59C-K



WDO-59C-SS-K



WDO-59D

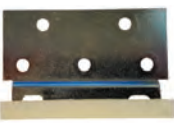

WDO-59D-K



WDO-59E



WDO-59E-K



Door Parts and Equipment

Door Gib Assemblies



WDO-59H



WDO-59J



WDO-67

S.E.E.S. #	O.E.M. #	Description
WDO-59H		Gib Assembly, 5/8" Offset x 4" W 1-1/2" Deep, with Gib
WDO-59J		Mounting Hardware for WDO-59 Series, Pack of 50 screws
WDO-59K	W905	Door Gib, 4" No Offset with Insert, (3) Hole, nylon gib with hardware
WDO-67	195C978H01	Safety Gib

SEES-ENFORCER-001
7/16"



SEES-ENFORCER-002
15/32"

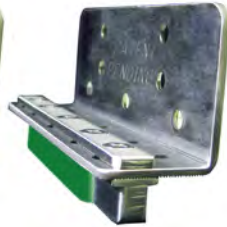

SEES-ENFORCER-003
1/2"



SEES-ENFORCER-004
17/32"



SEES Enforcer Door Gib Kits

S.E.E.S. #	Description
SEES-ENFORCER-001	SEES Safety Door Guide, Heavy Duty, Stainless Steel, Adjustable guide, with 7/16" nylon gib
SEES-ENFORCER-002	SEES Safety Door Guide, Heavy Duty, Stainless Steel, Adjustable guide, with 15/32" nylon gib
SEES-ENFORCER-003	SEES Safety Door Guide, Heavy Duty, Stainless Steel, Adjustable guide, with 1/2" nylon gib
SEES-ENFORCER-004	SEES Safety Door Guide, Heavy Duty, Stainless Steel, Adjustable guide, with 17/32" nylon gib
SEES-ENFORCER-010	SEES Safety Door Guide, Heavy Duty, Stainless Steel, Adjustable guide, with 23/64" nylon gib
SEES-ENFORCER-GIB-010	Replacement Door Gib, Nylon, 23/64" wide
SEES-ENFORCER-HDW	Bag Of 50 Mounting Screws for Enforcer Door Gib
SEES-ENFORCER-LP-R	SEES Safety Door Guide, Stainless Steel, Low Profile (Red) Adjustable guide, with 7/16" nylon gib

Enforcer EDGE



SEES-ENFORCER-EDGE-G

SEES Enforcer EDGE

S.E.E.S. #	Description
SEES-ENFORCER-EDGE-G	SEES Safety Door Guide, Stainless Steel, 0"-5/16" Offset with Green 15/32" Gib
SEES-ENFORCER-EDGE-R	SEES Safety Door Guide, Stainless Steel, 0"-5/16" Offset with Red 7/16" Gib
SEES-ENFORCER-EDGE-W	SEES Safety Door Guide, Stainless Steel, 0"-5/16" Offset with White 1/2" Gib
SEES-ENFORCER-EDGE-B	SEES Safety Door Guide, Stainless Steel, 0"-5/16" Offset with Blue 17/32" Gib

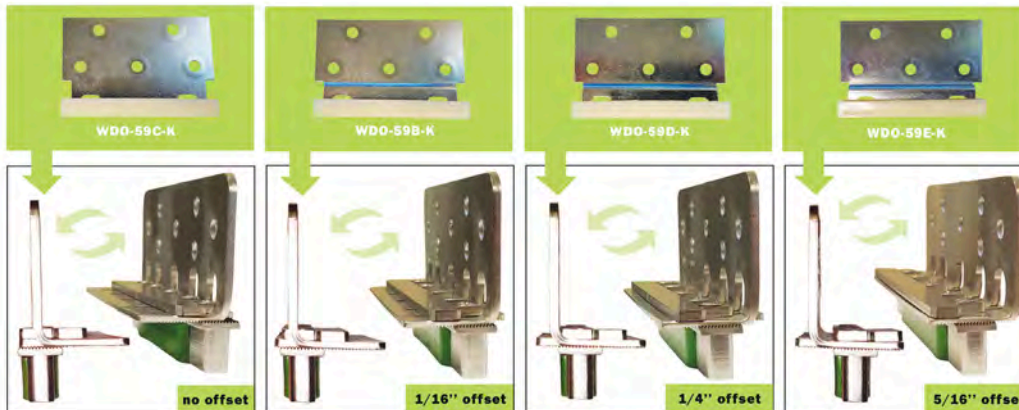

Door Parts and Equipment

Single Slide or Two Speed Applications

Used On ECI 895 and all GAL Door Operators

S.E.E.S. #	O.E.M. #	Description
SDO-101	892-3006	Door Clutch, 30" to 34"
SDO-102	892-3008	Door Clutch, 35" to 39"
SDO-103	892-3012	Door Clutch, 45" to 54"
SDO-104	892-30**	Door Clutch, 55" +
SDO-129	892-5006-LH	Door Clutch, LH, 30" to 34"
SDO-130	892-5008-LH	Door Clutch, LH, 35" to 39"
SDO-131	892-5010-LH	Door Clutch, LH, 28" to 29" & 40" to 44"
SDO-133	892-50**-LH	Door Clutch, LH, 55" +
SDO-134	892-5006-RH	Door Clutch, RH, 30" to 34"
SDO-135	892-5008-RH	Door Clutch, RH, 35" to 39"
SDO-136	892-5010-RH	Door Clutch, RH, 28" to 29" & 40" to 44"
SDO-137	892-5012	Door Clutch, LH, RH, 45" to 54"
SDO-138	892-50**-RH	Door Clutch, RH, 55" +

■ SDO-101 Thru SDO-104 Does Not Include Restrictor Assembly

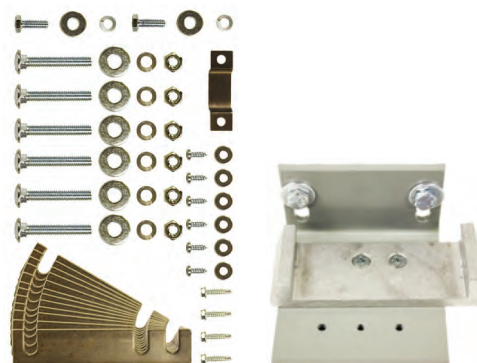

SDO-129



SDO-130

Used On ECI 1000/1010 & MCE Smartraq Door Operators

S.E.E.S. #	O.E.M. #	Description
SDO-105	892-4006	Door Clutch, 30" to 34"
SDO-106	892-4008	Door Clutch, 35" to 39"
SDO-107	892-4010	Door Clutch, 28" to 29" & 40" to 44"
SDO-108	892-4012	Door Clutch, 45" to 54"
SDO-109	895-40**	Door Clutch, 54" +
SDO-158	892-6006-LH	Door Clutch, LH, 30" to 34"
SDO-159	892-6008-LH	Door Clutch, LH, 35" to 39"
SDO-160	892-6010-LH	Door Clutch, LH, 28" to 29" & 40" to 44"
SDO-161	892-6012-LH	Door Clutch, LH, 45" to 54"
SDO-162	892-60**-LH	Door Clutch, LH, 55" +
SDO-163	892-6006-RH	Door Clutch, RH, 30" to 34"
SDO-164	892-6008-RH	Door Clutch, RH, 35" to 39"
SDO-165	892-6010-RH	Door Clutch, RH, 28" to 29" & 40" to 44"
SDO-166	892-6012-RH	Door Clutch, RH, 45" to 54"
SDO-167	892-60**-RH	Door Clutch, RH, 55" +
SDO-1010	ECI1010	Door Operator, ECI-1010 LH or RH
SDO-1010CP	ECI1010CP	Door Operator, ECI-1010 LH or RH, Center Parting

■ SDO-105 Thru SDO-109 Does Not Include Restrictor Assembly.



SDO-135

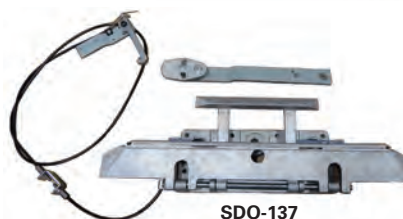

SDO-137

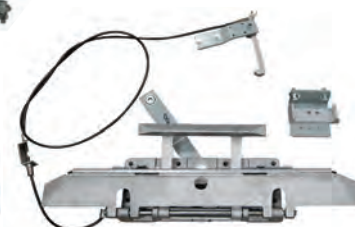

SDO-164

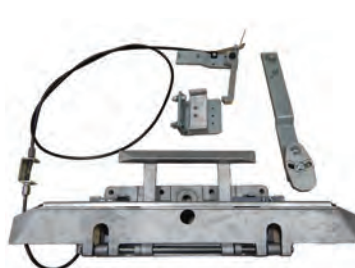

SDO-165

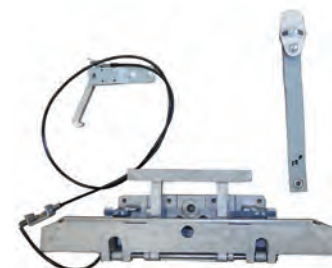

SDO-166



SDO-175



SDO-176



SDO-184



SDO-061R



SDO-062

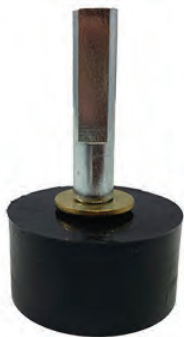

SDO-066

Used On VFE2500 Harmonic Door Operators

S.E.E.S. #	O.E.M. #	Description
SDO-110	892-8006-1	Door Clutch, 30" to 34"
SDO-111	892-8008-1	Door Clutch, 35" to 39"
SDO-112	892-8010-1	Door Clutch, 28" to 29" & 40" to 44"
SDO-113	892-8012-1	Door Clutch, 45" to 54"
SDO-114	892-80**-1	Door Clutch, 55" +
SDO-143	892-8006-LH	Door Clutch, LH, 30" to 34"
SDO-144	892-8008-LH	Door Clutch, LH, 35" to 39"
SDO-145	892-8010	Door Clutch, 28" to 29" & 40" to 44"
SDO-146	892-8012	Door Clutch, LH/RH, 45" to 54"
SDO-147	892-80**-LH	Door Clutch, LH, 55" +
SDO-148	892-8006-RH	Door Clutch, RH, 30" to 34"
SDO-149	892-8008-RH	Door Clutch, RH, 35" to 39"
SDO-152	892-80**-RH	Door Clutch, RH, 55" +

■ SDO-110 Thru SDO-114 Does Not Include Restrictor Assembly.

All ECI Door Operators

S.E.E.S. #	O.E.M. #	Description
SDO-115	892-3008-LD	Door Clutch, 28" +
SDO-157	892-6008-LD	Door Clutch, 28" +

■ SDO-115 Does Not Include Restrictor Assembly.

Restrictor Parts

S.E.E.S. #	O.E.M. #	Description
SDO-175	892-3029	Keeper and Hook, Assembly Complete
SDO-175A	892-3023	Hook Assembly Only
SDO-175B	892-3026	Keeper Assembly Only
SDO-176	892-3021	Cable, Clutch Restrictor
SDO-177	892-3004	Door Vane, Replacement for ECI Door Clutches

330A Hydro Entrance Header

S.E.E.S. #	O.E.M. #	Description
GDO-3C	INT2H-0015N, INT-1-5, INT1H-0017N	Contact, Bridging Block for GDO-3 & 3A
SDO-184	6997C33G01	Contact Latch Assembly with Contact Replaceable Beak
SDO-061R	6997C32G01	Drive Block Assembly, RH 330A Hydro Entrance Header
SDO-061L	6997C32G02	Drive Block Assembly, LH 330A Hydro Entrance Header
SDO-062	7262C37G02	Spirator Assembly, Phase II 330A Hydro Entrance Header
SDO-063	6993C54G01	Interlock Bracket Assembly, 330A Hydro Entrance Header
SDO-065	962718	Encoder Pulley with Magnet Assembly
SDO-066	6993C81H01	Drive Block Roller. 330A
SDO-067	5062A95H01	Bumper for 330A Drive Block
SDO-068	5062A98H01	Latch Bumper for 330A Drive Block

Door Parts and Equipment

Center Parting Applications

Used On ECI 895 and all GAL Door Operators

S.E.E.S. #	O.E.M. #	Description
SDO-116	892-3005-CO	Door Clutch , door opening from 29" to 33"
SDO-117	892-3006-CO	Door Clutch , door opening from 34" to 49"
SDO-118	892-3008-CO	Door Clutch , door opening from 50" to 54"
SDO-119	892-30**-CO	Door Clutch , door opening from 55" +
SDO-139	892-5006-CO	Door Clutch , door opening from 29" to 33"
SDO-140	895-5006-CO	Door Clutch , door opening from 34" to 49"
SDO-141	892-5008-CO	Door Clutch , door opening from 50" to 54"
SDO-142	892-50**-CO	Door Clutch , door opening from 55" +

■ SDO-116 Thru SDO-119 Does Not Include Restrictor Assembly.

Used On ECI 1000/1010 & MCE Smarraq Door Operators

S.E.E.S. #	O.E.M. #	Description
SDO-120	892-4005-CO	Door Clutch , door opening from 30" to 33"
SDO-121	892-4006-CO	Door Clutch , door opening from 34" to 49"
SDO-122	892-4008-CO	Door Clutch , door opening from 50" to 54"
SDO-123	892-40**-CO	Door Clutch , door opening from 54" +
SDO-169	892-6006-CO	Door Clutch , door opening from 31" to 49"
SDO-170	892-6008-CO	Door Clutch , door opening from 50" to 54"
SDO-171	892-60**-CO	Door Clutch , door opening from 55" +

■ SDO-120 Thru SDO-123 Does Not Include Restrictor Assembly.

Used On VFE2500 Harmonic Door Operators

S.E.E.S. #	O.E.M. #	Description
SDO-124	892-8005-1CO	Door Clutch , door opening from 29" to 33"
SDO-125	892-8006-1CO	Door Clutch , door opening from 34" to 49"
SDO-126	892-8008-1CO	Door Clutch , door opening from 50" to 54"
SDO-127	892-8008-1CO	Door Clutch , door opening from 55" +
SDO-153	892-8005-CO	Door Clutch , door opening from 29" to 30"
SDO-154	892-8006-CO	Door Clutch , door opening from 31" to 49"
SDO-155	892-8008-CO	Door Clutch , door opening from 50" to 54"
SDO-156	892-80**-CO	Door Clutch , door opening from 55" +

■ SDO-124 Thru SDO-127 Does Not Include Restrictor Assembly.

All ECI Door Operators

S.E.E.S. #	O.E.M. #	Description
SDO-128	892-8008-1CO	Door Clutch , door opening from 29" +

■ SDO-128 Does Not Include Restrictor Assembly.



SDO-121

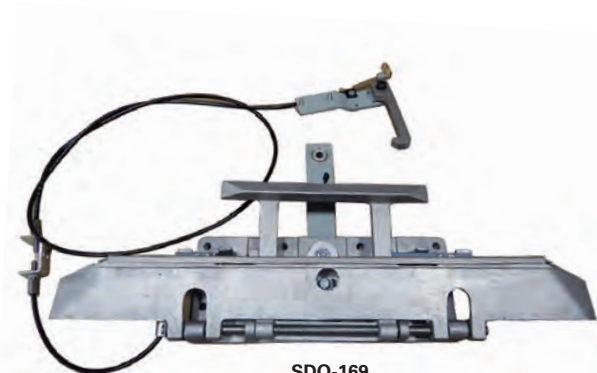

SDO-169



Door Parts and Equipment

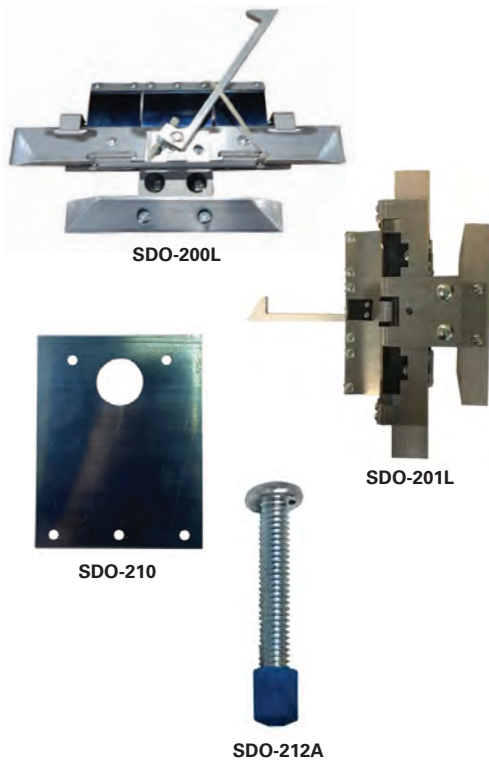

Used on 330A Door Operators

S.E.E.S. #	O.E.M. #	Description
SDO-185	6994C01G01	Door Lock Link Assembly, 330A Clutch Assembly
SDO-200L	8535C72G02	Clutch Assembly, LH, 330A SSSO/SSCO
SDO-200R	8535C72G01	Clutch Assembly, RH, 330A SSSO/SSCO
SDO-201L	8535C72G04	Clutch Assembly, LH, 330A 2SSO
SDO-201L	8535C72G04	Clutch Assembly, LH, 330A 2SSO
SDO-201R	8535C72G03	Clutch Assembly, RH, 330A 2SSO
SDO-202L	8535C72G02	Vane Assembly, LH, 330A Clutch
SDO-202R	8535C72G02	Vane Assembly, LH, 330A Clutch
SDO-203	5065A51H01	Retractor Ramp for QKS-16/330A Clutch
SDO-204	5062A92H01	Ramp Shim .060" for QKS-16/330A Clutch
SDO-205	8535C67G03	Actuator Assembly, for 330A Clutch
SDO-206	8535C66H01	Actuator Plate for 330A Clutch
SDO-207	8535C69H01	Open Vane for 330A Clutch
SDO-208	5265A52H01	Spring Hinge, 330A Clutch
SDO-209	8535C70H01	Boot Spacer for QKS-16/330A Clutch
SDO-210	6993C86H02	Center Spring for 321A/330A Clutch
SDO-211	6993C86H01	Outer Spring for 321A/330A Clutch
SDO-212		Replacement Screw, 1/4-20 x2" Nylon Rnd Hd for 330A Clutches, Bag of 5
SDO-212A		Upgraded Screw, 1/4-20 x 2" Steel Zinc Rnd Hd with Urethene tip for 330A Clutches, each

Door Motors

S.E.E.S. #	O.E.M. #	Description
WDO-61	569A700H01	Door Motor, 1/6 HP, 2000 RPM, 125 VDC, 1.3 Amp, shunt wound
WDO-61F	151B420G01	Door motor, WDO-61 with pulley, 16 teeth
WDO-61G	692B863G01	Door Operator Motor, 1/6 HP, 1150 RPM, 170 VDC, permanent magnet, flange mount
WDO-61H	7283C05H02	Door Operator Motor, 1/3 HP, 1725 RPM, 180 VDC, permanent magnet WDO-61HA Pulley, for WDO-61H
WDO-61J	7285C56H01	Door Motor, QKS-14 1/6 HP, 1140 RPM, 170 VDC foot mounting
SDO-180	1000-3006	1/3 HP Motor Assembly



Door Parts and Equipment

S.E.E.S. #	O.E.M. #	Description
SDO-034	909-7000	Door Hanger Assembly, ECI Roller And Eccentric
SDO-035	909-7006	Eccentric, ECI Upthrust Roller
SDO-036	909-6008	Door Roller, ECI 3-1/4" 5/8 ID
SDO-036A	909-6008	Door Roller, ECI 3-1/4" 6203 Brg with 5/8-18 Ecc. Shaft, Thin Shoulder
SDO-037	909-6045	Hanger Retainer, ECI Hall
SDO-038	909-6006	Hanger Shim Kit, ECI Door Suits 4-1/8" Pendant Bolt Ctrs
SDO-039	909-7002	Bracket, Anchor Ext
SDO-040	909-7003	Pulley Bracket, ECI Center Parting Assembly
SDO-041	909-7005	Cable Clamp Assembly, ECI
SDO-042	909-6014	Cable, ECI Pulley
SDO-043	909-6023	Support Bracket, for Car door and track hangers, End
SDO-044	909-6020	Support Bracket, for Car door and track hangers, 2 Speed, Center
SDO-045	909-6027	Track Bolts, for Car door and track hangers
SDO-046	890-3025	Mounting Plate, Track Interlock, Car Lock
SDO-047	909-6007	Mounting Bracket, Hanger/Keepr
SDO-048	909-6024	Adapter Plate, Hanger/Beak
SDO-050	895-3003	Drive Arm, for 42" CP Opening QKS-14
SDO-175	892-3029	Keeper and Hook, Assembly Complete
SDO-175A	892-3023	Hook Assembly Only
SDO-175B	892-3026	Keeper Assembly Only
SDO-176	892-3021	Cable, Clutch Restrictor
SDO-177	892-3004	Door Vane, Replacement for ECI Door Clutches



SDO-034



SDO-035

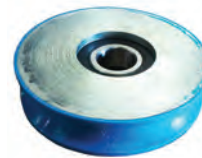

SDO-036



SDO-037



SDO-041



SDO-038



SDO-039



SDO-040



SDO-042



SDO-043



SDO-044



SDO-045



SDO-046



SDO-047

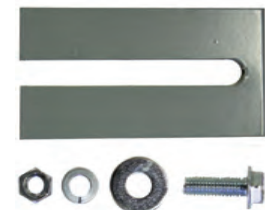

SDO-048

Door Parts and Equipment

S.E.E.S. #	O.E.M. #	Description
	WDO-60	Door Relating Cable , 12' L with two studs
	WDO-60A	Relating Cable Sheave nylon 2-3/4" dia. with bracket and mounting shaft
	WDO-60B	Pulley , 2-3/8" dia. aluminum .3937 ID, for relating cable
	WDO-60C	Door Relating Cable , WDO-60 with poly coated cable
	WDO-60D	Cable Kit , 8-1/2 ft long 1/8" cable with connecting hardware
	WDO-60D-S	Stud , for WDO-60D with Set Screw
	WDO-60E	Cable Hitch , Stud Only with Flat End
	WDO-60F	Tie Bracket for AC & AC2 hangers
	WDO-60G	Cable Assembly includes WDO-60D and E
	WDO-60J	Nut , 1/2-20 Hex Serrated Flange Nut Z.P
	WDO-60K	Relating Cable Kit , (2) Studs, (1) Hitch and Cable
	WDO-60L	Sheave Assembly , Relating Cable for Entry Doors
	WDO-60N	Sheave Assembly for Relating Cable
	WDO-60P	Relating Cable Assembly , Bracket with 16ft of Cable, Stud, (2) Pulleys, and Clamps
	WDO-60-SPECIAL	Door Relating Cable , (cut to length)
	WDO-61	Door Motor , 1/6 HP, 2000 RPM, 125 VDC, 1.3 Amp, shunt wound
	WCB-142	Carbon Brush , for WDO-61
	WDO-61A	Drive Pulley Assembly , E4 operator, motor side cover
	WDO-61B	Limit Switch Drive Pulley with steel bushing 1/2" hole, no flange
	WDO-61C	Power Pulley Assembly with bronze bushing 3/4" hole with flange
	WDO-61D	Shaft Assembly only for WDO-61
	WDO-61E	Shaft Assembly
	WDO-61F	Door Motor , WDO-61 with pulley, 16 teeth
	WDO-61G	Door Motor , 1/6 HP, 1150 RPM, 170 VDC, permanent magnet, flange mount
	WDO-63	Door Magnet
	WDO-64	Bumper , 1" OD x .520" L, .270" stem
	WDO-64A	Bumper , 1-1/4" OD x 15/16" L, 3/4" stem
	SCWH-15	Sheave , 60mm x 11mm, 6200 BRG, groove diameter: 48mm, ID: 10mm
	SDO-190	Cable , Door Relating Assembly

Door Parts and Equipment

S.E.E.S. #	O.E.M. #	Description
SDO-178	1000-3008	Motor Belt, AX53 Serrated VBelt
SDO-179	1000-3014	Chain Assembly CW Silencer Strap40
SDO-180	1000-3006	1/3 HP Motor Assembly
SDO-181	1000-3015	Chain Tension Roller Assembly ECI Door Clutches
SDO-18A	1000-3015	Chain Tension Roller Only ECI Door Clutches
SDO-182L	1000-3050-1L	1010 Operator 120V CP 8' Cab 40-44" LH
SDO-182R	1000-3050-1R	1010 Operator 120V CP, 8' Cab 40-44" RH
SDO-183	5203D67H14	Chain Sprocket Assembly QKS-15 14T
SDO-185	6994C01G01	Door Lock Link Assembly, 330A Clutch Assy
SDO-186	1000-3026	Slotted "C" Linkage Assembly
SDO-187	1000-3025	Tapped "C" Linkage Assembly
F-DC-1		Door Controller, Fermator VVVF
F-DC-VVVF4		Door Controller, Fermator VVVF4+
F-BELT-1		Fermator Door Belt



SDO-178



SDO-179



SDO-180



SDO-181

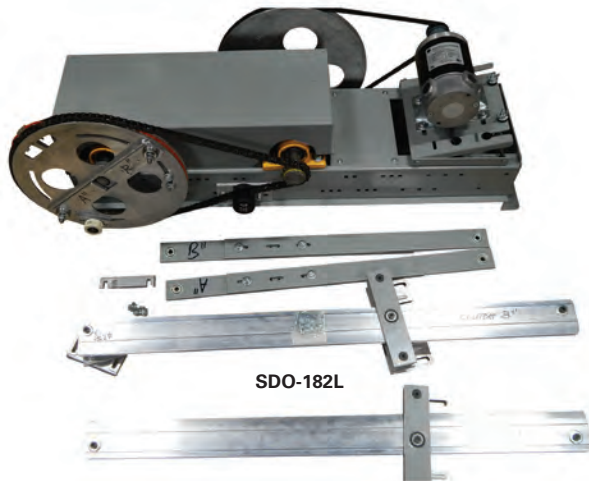

SDO-182L

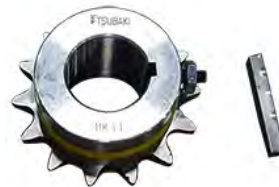

SDO-183



F-DC-VVVF4

Maintenance Kits

S.E.E.S. #	O.E.M. #	Description
SMK-001A	A330A	For Schindler 330A Maintenance Kit A
SMK-001B	A330B	For Schindler 330A Maintenance Kit B
SMK-001C	A330C	For Schindler 330A Maintenance Kit C

Electronic Components



WEC-15



WEC-54



WEC-16

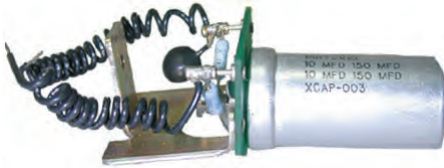

WEC-18



WEC-22

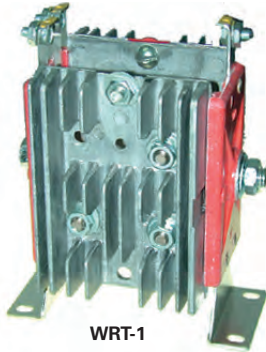

WRT-1



WRT-2



WRT-3



WRT-4

Capacitors For DM Controllers

S.E.E.S. #	O.E.M. #	Description
WEC-15	576B887G02 K7344H02	Capacitor, 150 MFD, 150 VDC, 2 wires
WEC-54	CGS362T200V4C	Capacitor, 3600 MFD, 200 VDC

Capacitors For STL Relays

S.E.E.S. #	O.E.M. #	Description
WEC-16	K3412H01	Capacitor, 90-110 MFD, 125 WVDC

Capacitors For EST Relays

S.E.E.S. #	O.E.M. #	Description - Time Range
WEC-18	466D034G01	Capacitor, 10 MFD, .1 to .6 Sec.
WEC-19	466D034G02	Capacitor, 50 MFD, .5 to 3.0 Sec.
WEC-20	466D034G03	Capacitor, 150 MFD, 1.5 to 9.0 Sec.
WEC-21	466D034G04	Dual Time Capacitor, 10 MFD without diode .1 to .6 Sec. Add.
WEC-22	466D034G05	Dual Time Capacitor, 20 MFD, without diode .2 to 1.2 Sec.
WEC-23	466D034G06	Dual Time Capacitor, 50 MFD, without diode .5 to 3.0 Sec. Add.
WEC-24	466D034G07	Dual Time Capacitor, 150 MFD, without diode 1.5 to 9.0 Sec. Add.
WEC-25	466D034G08	Capacitor, 20 MFD, 2 to 1.2 Sec.

■ Above capacitors are 150 VDC

Rectifiers

S.E.E.S. #	O.E.M. #	Description
WRT-1	195C928G01, 630B077H01, 478C156G01	Three Phase Rectifier, 35A, 300 V
WRT-2	151B931G01	Rectifier solid state 20 A, 300V
WRT-3		Zener Operator, for E-4A 10V, 50 W
WRT-4	X45AS2H24	Rectifier, Zener, 130V, 1 W

Electronic Components

Tubes

S.E.E.S. #	O.E.M. #	Description
WET-1	K3827H01	Thyratron Tube, 2A3
WET-2	M5509H01	Thyratron Tube, 2050
WET-3	H3090H11	6570 Tube Replacement. This solid state unit replaces tube 6570
WET-4	K4336H01	Tube, 1C21
WET-5		Tube, 2D21
WET-6		Tube, 12AX7A
WET-7A		Tube, Electron Original #6012



Breaker

S.E.E.S. #	O.E.M. #	Description
SCEP-3	181369	Breaker



Fans

S.E.E.S. #	O.E.M. #	Description
SCF-1	142984	Fan, for RV140 380-400V
SCF-2		Fan, for VF140, 100/220/230V, 50/60HZ, 30 Watts
SCF-3		Fan, for VF140, 220 VAC, 50/60HZ, 40 Watts



FOR SCHINDLER/WESTINGHOUSE



Machine Parts

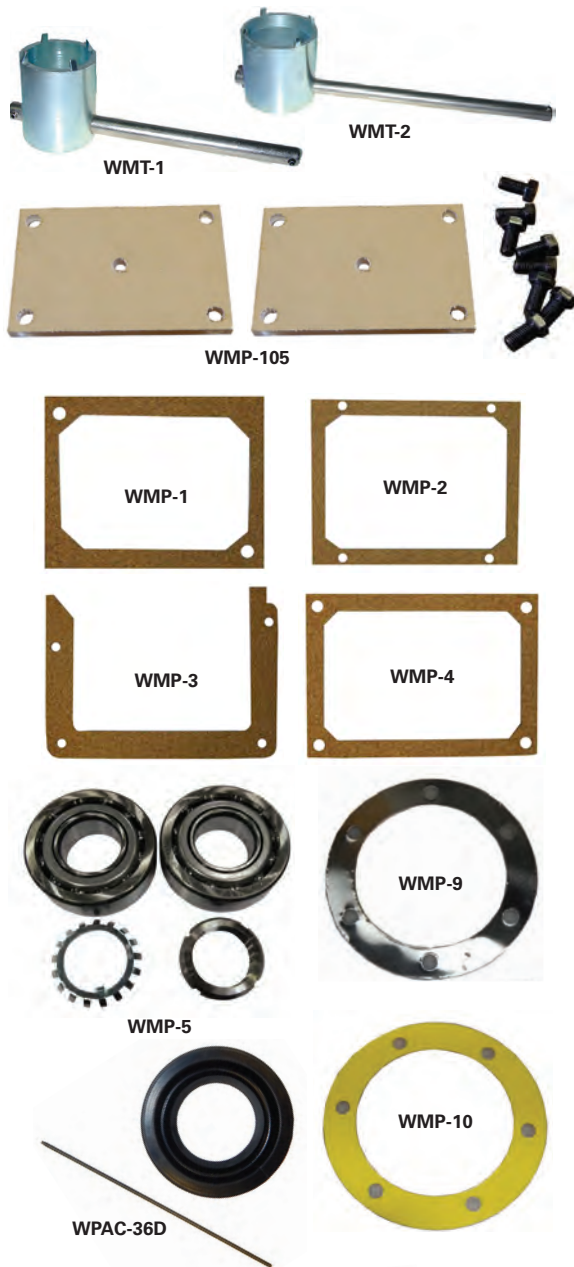

S.E.E.S. #	Description
WMT-1	Thrust Bearing Tool for #18 Machine, 2-1/2" ID
WMT-2	Thrust Bearing Tool for #28, #38, #57 Machine, 3-1/2" ID
WMP-105	Visual Inspection Plate, general mach #28, 38, 57, 61

#18 Machine

103D907,103D899

S.E.E.S. #	O.E.M. #	Description
WMP-1	195C574H02	Hand Hole Gasket
WMP-2	195C574H01	Front Cover Gasket
WMP-3	195C574H04	Housing Gasket
WMP-4	195C574H06	Hand Hole Gasket, lower
WMP-5	X18CS1H12, X6PS1H07, X4FS1H05	Kit: Thrust Bearings Lock Washer Lock Nut
WMP-6	630B301H01	Gasket .010, Thrust bearing end
WMP-7	630B301H05	Gasket .125, Thrust bearing end
WMP-8	630B301H02	Shim .005, pedestal
WMP-9	630B301H03	Shim .007, pedestal
WMP-10	630B301H04	Shim .020, pedestal
WMP-11	X6LS1H41	Felt Washer, worm shaft, 3.25" x 1.25"
WMP-12	682A092H01	Front Bearing Gasket, worm shaft
WPAC-36C	X30ES1H12	Seal, pedestal, 2-9/16" x 3-3/4" x 3/8"
WPAC-36D	X30ES1H13	Seal, worm shaft, 1-3/4" x 3-3/16" x 1/2"
WMP-14	195C572G01	Plunger Assembly for brake
WMP-15	X6LS2H42	Felt washer for brake, 4" x 2"
WMP-16	195C572H04	Bushing, bronze, for brake 2" OD, 3-3/16 OL
WMP-17	X6AS1H27	Leather Washer for brake
WC-85	X19PS1G08	Coil, for brake
WMP-23	195C615H02	Oil Wiper Segment
WMP-24	X9BS1H03	Oil Wiper Spring
WMP-25	630B301H01	Gasket, pedestal sheave side
WMP-25A	6918C45H01	Sheave Seal
WMP-26	692B273H01	Filter
WMPK-1		Machine Seal, Shim and gasket kit

■ Kits do not include bearings.



Machine Parts

#27 Machine

W732, W746, W768, W788

S.E.E.S. #	O.E.M. #	Description
WMP-27	R5027H03	Hand Hole Gasket
WMP-27A	R9172H01	Front Cover Gasket
WMP-28	X18CS1H06 K3126H01 X4CS1H08	Kit: Thrust bearing Thrust bearing washer Lock nut
WMP-28B		Thrust Bearing Set, #27 machine, 2 bearings
WMP-29	R7923H05	Gasket
WMP-30	R7923H03	Thrust Bearing Gasket
WMP-31	X27AS1H11	Shim, .005, pedestal sheave side
WMP-32	X27AS1H13	Shim, .020, pedestal sheave side
WMP-33	R7920H05	Oil Wiper Segment
WMP-33A	R7921G01	Plunger Assembly
WMP-33B	R7921H04	Bushing, 2-1/4" OD, 3-1/8" OL
WMP-34	X9BS1H27	Oil Wiper Spring
WMP-35	M3999H06	Gasket, pedestal sheave side
WMPK-2		Machine Seal, Shim and gasket kit
WPAC-36F	R7311H22, 23	Seal, worm shaft
WPAC-36I	X30AS1H11	Seal, pedestal (W768 & W788)
WPAC-36K	M3427H06	Seal, pedestal (W732 & W746)

■ Kits do not include bearings.



Brake Parts

For Machine #s 18, 27, 28, 28A, 37, 38, 57, 58, and 61

S.E.E.S. #	O.E.M. #	Description
WMP-13	630B422H01	Micro Switch
WMP-18	M3665G01	Brake Switch Assembly
WMP-20A	R7533H01	Contact Plate
WMP-20B	M3455H03	Bridge Plate
WMP-21	X9AS1H03	Spring
WMP-22	X12DS1H12	Pin
WMP-36	X27NS1H07	Felt Washer
WRP-8	R7533G04	Brake Cooling Contact Assy, silver

#28 and #28A Machines

534F911, 534F834

S.E.E.S. #	O.E.M. #	Description
WMP-38	X18CS1H13 X6P9	Kit: Thrust bearings Lock washer, Lock nut
WMP-39	215B755H02	Outer End Thrustbearing Cover Gasket
WMP-40	215B755H01	Inner Thrustbearing Assembly Gasket
WMP-41	R5026H09	Shim
WMP-42	M3999H04	Front Bearing Gasket, worm shaft
WMP-43	216B129H01	Gear Housing Gasket
WMP-27	R5027H03	Hand Hole Gasket
WMP-45	144A989H01	Front Side Cover Gasket
WMP-46	X18D4	Bearing, pedestal sheave
WMP-47	X18D33	Bearing, gear side
WMP-48	X27AS1H03	Shim, .005, sheave side



Machine Parts

#28 and #28A Machines

534F911, 534F834

S.E.E.S. #	O.E.M. #	Description
WMP-49	X27AS1H18	Shim, .007, sheave side
WMP-50	X27AS1H04	Shim, .020, sheave side
WPAC-39A	X30ES1H19	Split Seal, worm shaft
WPAC-36B	X30ES1H15	Seal, pedestal
WMP-51	322C062H02	Oil Wiper Segment
WMP-24	X9BS1H03	Oil Wiper Spring
WMP-3	195C574H04	Housing Gasket
WMP-60	M3999H06	Gasket, pedestal sheave side
WC-84	X19PS1G01	Coil, brake
WMP-53	144A523G01	Plunger Assembly, brake
WMP-54	R8757H01	Bronze Bushing, 2.51" ID 2.75" OD, 5-1/16" OL
WMP-54A		Bronze Worm Shaft Bushing for G01 assembly
WMP-54B		Bronze Worm Shaft Bushing
WMP-55	X6LS1H29	Felt Washer
WMP-55A	X6AS1H19	Leather Washer
WPAC-15	6917C91G02	Machine Kit, #28
WPAC-35D	6917C89H01	Sheave Seal, #28 Machine Split
WMPK-3		Machine Seal, Shim and gasket kit



WPAC-39A

WMPK-3

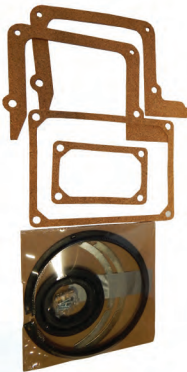

WPAC-15



WMP-51



WMP-63



WMP-54A



WMP-54B



WMPK-5

#37 Machine

WW167, WW194, WW503

S.E.E.S. #	O.E.M. #	Description
WMP-27	R5027H03	Hand Hole Gasket
WMP-57	R5027H15	Front Cover Gasket
WMP-58	X18CS1H04	Kit: Thrust bearing
	K1917H05	Lock Washer
	M4202H01	Lock Nut
WMP-59	R5027H05	Thrust Bearing Gasket
WPAC-36E	R7311H17	Seal, worm shaft
WPAC-36L	M3427H01	Seal, pedestal
WMP-35	M3999H06	Gasket, pedestal sheave side
WMP-61	R8906H02	Oil Wiper Segment
WMP-24	X9BS1H03	Oil Wiper Spring
WC-84	X19PS1G01	Coil, brake
WMP-54	R8757H01	Bronze Bushing, 2.51" ID 2.75" OD, 5-1/16" OL
WMP-55	X6LS1H29	Felt Washer
WMPK-4		Machine Seal, Shim and gasket kit

#38 Machine

534F909, 534F812

S.E.E.S. #	O.E.M. #	Description
WMP-38	X18CS1H13, X6P9	Kit for 1/2" Cables: Thrust bearings Lock washer, Lock nut
WMP-63	X18CS1H11	Kit for 5/8" Cables: Thrust bearings
WMP-39	215B755H02	Thrust Bearing End Gasket
WMP-40	215B755H01	Gasket, front bearing worm shaft
WMP-41	R5026H09	Shim, thrust bearing
WMP-27	R5027H03	Hand Hole Gasket
WMP-64	215B690H01	Gear Housing Gasket
WMP-65	144A524H01	Front Side Gasket
WMP-66	X18DS1H11	Bearing, pedestal sheave side
WMP-67	X18DS2H35	Bearing, gear end
WMP-68	X27AS1H16	Shim, .005 pedestal sheave side
WMP-69	X27AS1H19	Shim, .007 pedestal sheave side
WMP-70	X27AS1H17	Shim, .020 pedestal sheave side
WPAC-35B	X30ES1H16	Seal, pedestal, with spring
WPAC-41A	X30ES1H18	Seal, pedestal (Type 198C267 only)
WMP-71	321C599H02	Oil Wiper Segment
WMP-24	X9BS1H03	Oil Wiper Spring
WMP-72	M3999H03	Gasket, pedestal sheave side
WC-84	X19PS1G01	Coil, brake
WMP-53	144A523G01	Plunger Assembly
WMP-54	R8757H01	Bronze Bushing, 2.51" ID 2.75" OD, 5-1/16" OL
WMP-55	X6LS1H29	Felt Washer
WPAC-35C		Pedestal Sheave Seal, 9.75" ID split lip with hole
WPAC-40A	W872E20, X30ES1H20	Seal, #38 Hoist Machine Worm
WMPK-5		Machine Seal, Shim and gasket kit

■ Kits do not include bearings.

Machine Parts

#57 Machine

WW179, WW199, and WW504

S.E.E.S. #	O.E.M. #	Description
WMP-38	X18CS1H13 X6P9	Kit: Thrust bearings Lock washer, and Lock nut
WMP-74	R9115H02	Front Cover Gasket
WMP-75	R9115H01	Housing Gasket Front
WMP-76	R5027H13	Gasket , front & back worm shaft
WMP-77	R5027H02	Gasket , thrust bearing
WMP-41	R5026H09	Shim , thrust bearing
WPAC-41B	X30ES1H09	Seal , worm shaft
WPAC-36M	M3427H02	Seal , pedestal
WMP-78	R5026G01	Plunger assembly
WMP-79	R5026H06	Bushing
WMP-80	X6LS1H07	Felt Washer , 5-1/2" x 3"
WMP-81	X27AS1H23	Shim , .005, pedestal sheave side
WMP-81A		Shim , .005 pedestal sheave 5/8" cable
WMP-82	X27AS2H33	Shim , .007, pedestal sheave side
WMP-82A	X27AS2533	Shim , .007 pedestal sheave 5/8" cable
WMP-83	X27AS1H22	Shim , .020, pedestal sheave side
WMP-83A	X27AS1H22	Shim , .020 pedestal sheave 5/8" cable
WMP-84	M3999H02	Gasket , pedestal
WMP-88	R9080H02	Oil Wiper Segment
WMP-89		Vent Valve , 1/8" NPT for Gear Case
WMP-24	X9BS1H03	Oil Wiper Spring
WMPK-6		Machine Seal , Shim and gasket kit

#61 Machine

W770, 626D831

S.E.E.S. #	O.E.M. #	Description
WMP-27	R5027H03	Hand Hole Gasket
WMP-93	R7532H07	Housing Gasket Front
WMP-94	X18CS1H05 K3126H03	Kit: Thrust bearings Thrust Bearing Washer Lock Nut
WMP-95	R5027H12	Gasket
WMP-41	R5026H09	Gasket , thrust end
WPAC-41B	X30ES1H09	Seal , worm shaft
WPAC-36N	M3427H05	Seal , pedestal
WMP-96	R5027H11	Front Bearing Gasket
WMP-97	M3999H01	Gasket , pedestal
WMPK-8		Machine Seal , Shim and gasket kit

#81 Machine

U18, 627D585

S.E.E.S. #	O.E.M. #	Description
WMP-27	R5027H03	Hand Hole Gasket
WMP-100	X18CS1H07 K3126H04	Kit: Thrust bearings Thrust Bearing Washer
WMP-102	R8384H02	Thrust Bearing Gasket
WPAC-36H	R7311H25	Seal , worm shaft
WPAC-36P	M3427H07	Seal , pedestal, 2.56" ID, 3.751" OD 3/8" Thick
WMP-106	534F893G07	Break Bushing , Bronze
WMPK-9		Machine Seal , Shim and gasket kit

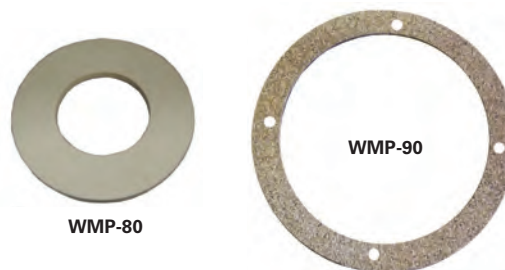

#58 Machine

S.E.E.S. #	O.E.M. #	Description
WMP-27	R5027H03	Hand Hole Gasket
WMP-74	R9115H02	Front Cover Gasket
WMP-75	R9115H01	Housing Gasket
WMP-38	X18CS1H13 X6P9	Kit: Thrust bearings Lock washer Lock nut
WMP-39	215B755H02	Gasket , thrust bearing end
WMP-40	215B755H01	Front Bearing Gasket Worm Shaft
WMP-41	R5026H09	Shim , thrust bearing
WPAC-41C	X30ES1H14	Seal , worm shaft
WPAC-41	X30ES1H21	Seal , worm shaft
WPAC-41D	X30ES1H17	Seal , pedestal
WMP-90	630B352H01	Cork Gasket , worm shaft
WMP-78	R5026G01	Plunger Assembly , brake
WMP-79	R5026H05	Bronze Bushing , brake
WMP-80	X6LS1H07	Felt Washer
WMP-55A	X6AS1H19	Leather Washer
WMPK-7		Machine Seal , Shim and gasket kit

■ Kits do not include bearings.

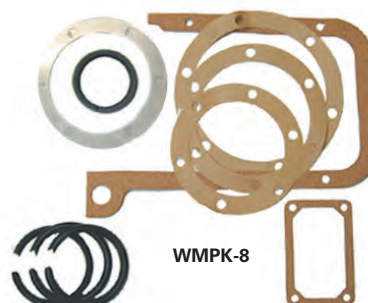

Machine Parts

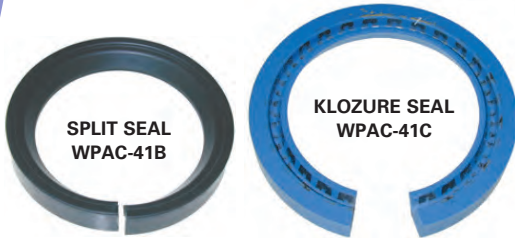

Machine Seals for Traction Equipment

S.E.E.S. #	O.E.M. #	ID x OD x Thick	Application
WPAC-35C	2890C79H01	9-3/4" x 11-1/2"	#38 Worm
WPAC-35B	X30ES1H16	4 x 5" x 1/2"	#38 Gear
WPAC-36B	X30ES1H15	3-11/16" x 4-3/4" x 1/2"	#28 Gear
WPAC-36C	X30ES1H12	2-9/16" x 3-3/4" x 3/8"	#18 Gear
WPAC-36D	X30ES1H13	1-3/4" x 3-3/16" x 1/2"	#18 Worm
WPAC-36E	R7311-H17	2-7/16" x 3-7/16" x 11/16"	#35, #36, #37 Worm
WPAC-36F	R7311-H23	2-1/8" x 3-9/64" x 11/16"	#25, #26, #27, #31 Worm
WPAC-36G	R7311-H13	2.618" x 3.9375" x 11/16"	#60 Worm
WPAC-36H	R7311-H25	4" x 5" x 11/16"	#81 Worm
WPAC-36I	X30AS1H11	2.750" x 3.7495" x 1/2"	
WPAC-36J	X30AS1H08	29/32" x 1.575" x 5/16"	
WPAC-39A	X30ES1H19	2-1/2" x 3-1/2" x 7/16"	#28 Worm
WPAC-40A	X30ES1H20	3-1/8" x 4-1/4" x 1/2"	#38 Worm
WPAC-41	X30ES1H21	3-1/4" x 4-1/4" x 1/2"	#38, #57, #61 Worm
WPAC-41A	X30ES1H18	4-1/2" x 5-1/2" x 1/2"	#38 Gear
WPAC-41B	X30ES1H9	3-1/4" x 4-1/4" x 11/16"	#57, #61 (#58 old style)
WPAC-41C	X30ES1H14	3-1/4" x 4-1/2" x 5/8"	#58 (new style)
WPAC-41D	X30ES1H17	5 x 6" x 1/2"	#58 Gear

S.E.E.S. #	O.E.M. #	Description	ID x OD x Thick
WPAC-36K	M3427H06	#27 Pedestal seal	2.75" x 3.55" x 0.40"
WPAC-36L	M3427H01	#37 Pedestal seal	3.25" x 4.30" x 0.54"
WPAC-36M	M3427H02	#57 Pedestal seal	5.25" x 6.05" x 0.52"
WPAC-36N	M3427H05	#61 Pedestal seal	4.30" x 5.40" x 0.54"
WPAC-36P	M3427H07	#81 Pedestal seal	2.56" x 3.75" x 0.375"

Seals for Hydraulic Jacks

S.E.E.S. #	O.E.M. #	Jack Size
WPAC-16	691B864H02, 196C145H05	4-1/2"
WPAC-16A	7264C45H05	5"
WPAC-18A	196C145H08	6"
WPAC-19	691B864H05, 7264C45H08	6-1/2"

Bearing Sets

S.E.E.S. #	Description
WBRG-001	Bearing Set, Westinghouse Tail Sheave, Two sets required

Printed Circuit Boards

SE.E.S. #	O.E.M. #	Description
WPC-1	195C503H01	Printed Circuit Timer, Dual Timer .5 seconds-2 minutes
WPC-1A	195C502G01	Printed Circuit Timer, MG shut down, timing 5 minutes
WPC-2	478C315G01, 478C315H02	Wye-Delta Timer, 5 minutes
WPC-4	477C843H03, 477C977G03	ERL Amplifier
WPC-5	195C252G03	Reverse Phase Relay
WPC-8	998C092H12	IO8 PCB
WPC-33	998C273H11	MTA PC Board
WPC-34	999C419H11	WC9 PC Board
WPC-14	998C210H24	EBC/ESC Board
WPC-35	998C153H14	MPT PC Board
WPC-27	7249C42H06	Power Supply
WPC-30	6996C11H14	Power Supply, 24 VDC
WPC-20	998C090H12	IO2 PCB Index A
WPC-21	998C091H12	IO6 PCB
WPC-29	2633C12G03	LZD Kit for TTL-DPG
SPC-001	8953050	PCB, door operator for Schindler
SPC-002	10003050	PCB, door operator for Schindler
SPC-013	221985	PCB, ANN PC board
SPC-014	222519	PCB, IGBT with GA board
SPC-015	223200	PCB, CPB/AUXF Joined PC board
SPC-011	387600	PCB, Processor board
SPC-16	223825	PCB, STDC board
SPC-17	590814	PCB, VLNA PCB
SPC-008	225825	PCB, CIO ACD1 PCB
SPC-005	225313	PCB, CHRIPHNA 4 QB PCB
SPC-007	225725	PCB, CHRIPHNA 5 without AC
SPC-006	225515	PCB, SMHC board
SPC-18	224313	PCB, CHRIPHNA 3 without AC
SPC-19	225723	PCB, SMTV PC board
SPC-20	590810	PCB, PEM1.Q ESC PCB
SPC-030A	51523328	PCB, CIOACD 3.Q Assembly
WPC-200	1185C43H04	PCB, PE2 PC board
WPC-201	998C225H12	PCB, VEC PC board
WPC-202	998C169H11	PCB, DPR PCB BB
WPC-203	998C238H12	PCB, V2V PC board
WPC-207	998C027H34	PCB, BFS1 PC board
SPC-85	3-4024669	PCB, Model V Amplifier PC board
SPC-201	SY383600	PCB, PF1.Q ESCA ck pcr1 under #sy387600
SPC-202	225094	PCB, SFCB 1.Q (998C148H26)
SPC-203	999C00326	PCB, TRM
SPC-204	590810, 50606954	PCB, PEM 1.Q Assembly Escalator Ne Version
SPC-206	9986002H14	PCB, PCB, MGI-A
SPC-207	693B110H01	PCB, TTL-DPG Load board
SPC-208	2244766	PCB, CIOHNA 2.Q PCB
SPC-209	590814	PCB, VLNA 2.Q PCB
SPC-211	225445	PCB, CRIPHNA 4.Q PCB (with access relay)
SPC-212	51515513	PCB, for Schindler Push Button



WPC-1

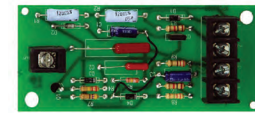

WPC-2



WPC-1A



WPC-4

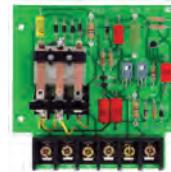

WPC-5

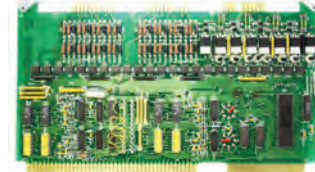

WPC-8



WPC-27



WPC-30

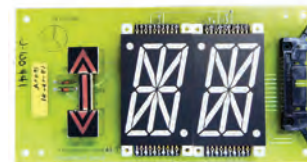

WPC-202



SPC-001

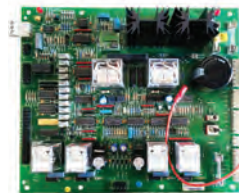

SPC-002



SPC-16



SPC-008



SPC-212

FOR SCHINDLER/WESTINGHOUSE

Printed Circuit Boards

TTL

S.E.E.S. #	O.E.M. #	Description
WPC-49	1185C43H04	PCB , PE2 PC Board
WPC-50	1185C32H01	PCB , IT3 PC Board
WPC-51	998C273H11	PCB , MTA PC Board
WPC-52	998C274H11	PCB , MTB PC Board
WPC-54	1185C38H01	PCB , PD4 PC Board
WPC-55	998C039H12	PCB , PD5 PC Board
WPC-56	998C098H37	PCB , PE3 PC Board
WPC-57	998C009H11	PCB , PLO PC Board
WPC-58	998C062H46	PCB , TM1 PC Board
WPC-59	998C063H23	PCB , TM2 PC Board

Q Boards

S.E.E.S. #	O.E.M. #	Description
SPC-021	206748	PCB , Board SIA8, Q
SPC-022	206816	PCB , Board SMTXV2, Q
SPC-023	222821	PCB , LANTHNA 1, Q
SPC-024	222824	PCB , Board Assembly PIHNA, 1, QC (4 per panel)
SPC-025	590098	PCB , RC 3.Q 630V./250V Assy
SPC-026	590882	PCB , DSFCR 1.Q VF170/280



SPC-024

World Class

S.E.E.S. #	O.E.M. #	Description
WPC-103	999C401H13	PCB , WCA PC Board
WPC-104	999C414H22	PCB , WC4 PC Board

Epoch I

S.E.E.S. #	O.E.M. #	Description
WPC-60	998C118H11	PCB , ASM PC Board
WPC-61	998C076H14	PCB , DDD PC Board Index A
WPC-62	998C120H11	PCB , DMM PC Board
WPC-63	998C204H12	PCB , DTS PC Board
WPC-64	998C090H12	PCB , IO2 PCB Index A
WPC-65	998C091H12	PCB , IO6 PC Board
WPC-66	998C092H12	PCB , IO8 PC Board
WPC-67	998C102H12	PCB , IOT keysheet Index A
WPC-68	998C002H14	PCB , MGI-A PC Board
WPC-69	998C111H11	PCB , TB1 PC Board
WPC-70	998C113H11	PCB , TB3 PC Board
WPC-11	998C153H15	PCB , MPT keysheet
WPC-19	998C080H15	PCB , MGA keysheet Index A

Epoch 2VA

S.E.E.S. #	O.E.M. #	Description
WPC-71	998C257H11	PCB , PTC PC Board
WPC-72	998C168H24	PCB , TRM Early Version
WPC-74	998C224H11	PCB , ENC PCB
WPC-75	998C255H14	PCB , MGC PC Board
WPC-76	998C254H12	PCB , MGS keysheet Index A ZEHNT
WPC-77	998C197H13	PCB , MTV keysheet PC Board
WPC-78	998C256H12	PCB , PTS PC Board
WPC-79	999C003H26	PCB , TRM PC Board
WPC-80	998C149H12	PCB , SPB PC Board
WPC-81	998C169H11	PCB , DPR PCB
WPC-25	998C276H22	PCB , TCP PC Board

Motrol

S.E.E.S. #	O.E.M. #	Description
WPC-82	998C108H12	PCB , ERA PCB Assembly
WPC-83	998C206H12	PCB , ETS PC Board
WPC-85	998C032H15	PCB , MS1 Keysheet
WPC-86	998C061H14	PCB , MS2 Board
WPC-87	998C127H14	PCB , MS6 PC Board
WPC-88	999C225H25	PCB , MSR PC Board
WPC-90	998C077H24	PCB , PM1 Keysheet index A
WPC-22	998C110H12	PCB , ERB PCB Assembly

300A

S.E.E.S. #	O.E.M. #	Description
WPC-16	998C246H12	PCB , MIO PCB Assembly
WPC-24	998C247H14	PCB , CIO PC Board
WPC-32	998C245H12	PCB , PIB PCB Assembly
WPC-18	998C272H13	PCB , REL PCB Assembly



WPC-16

Printed Circuit Boards

321A

S.E.E.S. #	O.E.M. #	Description
SPC-003	223956	PCB, CRIPHNA 2.QA Assembly
SPC-031	222923 590866	PCB, EBCOM68 Assembly

330A

S.E.E.S. #	O.E.M. #	Description
SPC-039	590862	PCB, GCIO360.QE Assembly

TXR5

S.E.E.S. #	O.E.M. #	Description
SPC-041	222920	PCB, LONIOH 16 Assembly
SPC-042	224310	PCB, SETSDL 1.QC Assembly
SPC-043	222533	PCB, LFTDPI50 Assembly QB
SPC-044	59324328	PCB, Single Button Board
SPC-045	9234329	PCB, Double Button Board

MPH I

S.E.E.S. #	O.E.M. #	Description
WPC-91	998C149H12	PCB, SPB PC Board
WPC-93	998C150H11	PCB, ECB PC Board (Chime Board)
WPC-94	998C146H22	PCB, HRM PC Board
WPC-95	998C202H12	PCB, PHC PC Board
WPC-96	998C164H13	PCB, DPB PC Assembly
WPC-9	998C145H24	PCB, MHP Printed Circuit Board
WPC-10	998C147H15	PCB, DCB Key Sheet Index A
WPC-23	998C173H22	PCB, NSP PCB

MPH II

S.E.E.S. #	O.E.M. #	Description
WPC-97	998C149H12	PCB, SPB PC Board
WPC-100	998C188H11	PCB, IOX PC Board
WPC-12	998C187H26	PCB, MHC PCB Assembly
WPC-15	998C216H28	PCB, RMH PCB Assembly

Miconic A

S.E.E.S. #	SCH/O.E.M. #	Description
WPC-37	998C198H12	PCB, DPI PCB Assembly
SPC-004	224213	PCB, SHVM 1.Q PCB Assembly
WPC-41	998C224H11	PCB, ENC PCB
WPC-17	998C255H14	PCB, MGC PC Board
WPC-42	998C254H12	PCB, MGS Keysheet Index A ZEHNT
WPC-13	998C197H13	PCB, MTV Keysheet PC Board
WPC-43	998C256H12	PCB, PTS PC Board
WPC-26	999C003H26	PCB, TRM PC Board
SPC-012	224310	PCB, SETSDL 1.QC PCB Assembly
WPC-44	998C239H11	PCB, DBC Keysheet
WPC-45	998C227H12	PCB, INT Keysheet
WPC-46	998C228H12	PCB, RDI Keysheet Index A
WPC-47	998C238H12	PCB, V2V PC Board
WPC-48	998C225H12	PCB, VEC PC Board

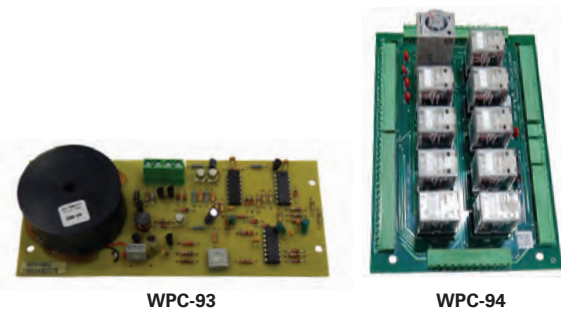

WPC-93

WPC-94

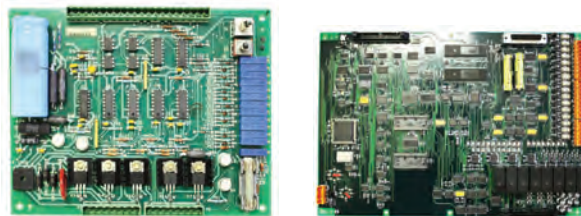

WPC-10

WPC-12



WPC-15



WPC-37



SPC-004

Miconic VM

S.E.E.S. #	O.E.M. #	Description
SPC-45	3-40290-58	PCB, SSCC PC Board
SPC-46	3-40338-17	PCB, CAMF PC Board
SPC-47	3-40332-63	PCB, EA2232. MA PC Board
SPC-48	3-40332-65	PCB, EK2264. MA PC Board
SPC-49	3-40232-32	PCB, Gearless PAS Board
SPC-50	3-40332-38	PCB, IG500 Pulse Tach PC Board
SPC-51	3-40341-30	PCB, MT1 PB PC Board Assembly
SPC-52	3-40340-68	PCB, PAS Geared Board
SPC-53	3-40332-60	PCB, PEC116.MA PC Board
SPC-54	3-40320-63	PCB, RCE Interface PC Board
SPC-55	3-40231-12	PCB, Safety PC Board
SPC-56	3-40342-45	PCB, Safety PC Board
SPC-57	3-40332-61	PCB, SUA116.MA PC Board
SPC-58	3-40337-62	PCB, UVPN 2512.MA PC Board
SPC-59	3-40332-62	PCB, VSR PC Board
SPC-60	3-40352-50	PCB, GAFC-L Gearless
SPC-61	3-40393-54	PCB, I/O PC Board CVT-1011

Miconic V

S.E.E.S. #	O.E.M. #	Description
SPC-62	3-40290-58	PCB, SSCC PC Board
SPC-63	3-40341-26	PCB, GAFC Geared MICONIC V PC Board
SPC-64	3-40340-45	PCB, MPSZ216.MA PC Board
SPC-65	3-40333-48	PCB, PAK216.MA 1092 DISPATCH PCB
SPC-66	3-40338-17	PCB, CAMF PC Board
SPC-67	3-40332-63	PCB, EA2232.MA PC Board, MICONIC V,
SPC-68	3-40332-65	PCB, EK2264.MA PC Board, MICONIC V
SPC-69	3-40232-32	PCB, Gearless PAS Board, MICONIC V,
SPC-70	3-40332-38	PCB, IG500 Pulse TACH PC Board
SPC-71	3-40341-30	PCB, MT1 PB PC Board Assembly
SPC-72	3-40340-68	PCB, PAS Geared Board
SPC-73	3-40332-60	PCB, PEC116.MA PC Board
SPC-74	3-40320-63	PCB, RCE INTERFACE PC Board
SPC-75	3-40332-61	PCB, SUA116.MA PC Board
SPC-76	3-40337-62	PCB, UVPN 2512.MA PC Board
SPC-77	3-40332-62	PCB, VSR PC Board

EVC ELC

S.E.E.S. #	O.E.M. #	Description
SPC-78	3-40220-54	PCB, Emergency Light PC Board & Battery
SPC-79	3-40155-92	PCB, Hi-Voltage Board MDL III/IV
SPC-80	3-40179-99	PCB, Leveling Control Board ELC, IV,
SPC-81	3-40143-00	PCB, Model III Leveling Decoder Board
SPC-82	3-40143-03	PCB, Model III/IV Power Supply
SPC-83	3-40162-07	PCB, Model III/IV Excess Error Board
SPC-84	3-40142-99	PCB, Model III/IV SCR Assembly
SPC-85	3-40246-69	PCB, Model V Amplifier PC Board
SPC-86	3-40143-02	PCB, SCR Trigger Board

Gold Flite

S.E.E.S. #	O.E.M. #	Description
SPC-87	3-40281-07	PCB, GMG Amplifier Board, GMG, Level C
SPC-88	3-40324-87	PCB, Step SW Relay Board
SPC-89	3-40280-18	PCB, Timer Display Board, GDC/GMG/GAC
SPC-90	3-40284-26	PCB, 90V Rev Phase Relay Board
SPC-91	3-40318-72	PCB, GDC Heatsink PC Board Assembly
SPC-92	3-40287-93	PCB, Gaciv Amplifier Board, Dynatro
SPC-93	3-40267-48	PCB, Pattern Board, GDC/GMG, Level F
SPC-94	3-40284-28	PCB, Rev Phase Relay Board, 180V
SPC-95	3-40324-83	PCB, Step Switch Mother Board, 120V
SPC-96	3-40305-20	PCB, Emergency Reset PCB, 24 VDC GDC/GMG/GAM
SPC-97	3-40324-80	PCB, Step Switch Mother Board, 24V
SPC-98	3-40280-14	PCB, Accesory Board, GDC/GMG/GAC
SPC-99	3-40256-98	PCB, G-F Pattern Gen Board (Earthquake)

Accu-Flite

S.E.E.S. #	O.E.M. #	Description
SPC-100	3-40005-27	PCB, Pulse gen board, ACCU/SAM/GAM
SPC-101	3-40006-59	PCB, Accuflite Pos. Interface board
SPC-102	3-40252-30	PCB, Amplifier board, ACCU, level C
SPC-103	3-40305-20	PCB, Emergency Reset PCB 24 VDC, GDC/GM
SPC-104	3-40280-89	PCB, Motor Feild Control Board, SAM/GAM
SPC-105	3-40280-85	PCB, Predictor Board, ACCU/SAM/GAM
SPC-106	3-40890-10	PCB, Amplifier Board, SAM/GAM
SPC-107	3-40277-03	PCB, Memory Board 64FLRS, ACCU/SAM/GA
SPC-108	3-40292-32	PCB, Interface Board, SAM/GAM
SPC-109	3-40231-72	PCB, GFC Board, GAM Level C
SPC-110	3-40292-28	PCB, Data Priority Board, 64FLRS, SAM

1092-IC

S.E.E.S. #	O.E.M. #	Description
SPC-112	3-4005-27	PCB, Pulse Gen Board, ACCU/SAM/GAM
SPC-113	3-40239-26	PCB, Posin Hall/Call PCB
SPC-114	3-40250-21	PCB, Car Control Board, 1092DRM
SPC-115	3-40012-24	PCB, Output Buff PCB Level B

Tru-Flite

S.E.E.S. #	O.E.M. #	Description
SPC-116	3-40233-09	PCB, Tru-Flite Amp Board, Level B

S.E.E.S. #	O.E.M. #	Description
SPC-117		Power Supply, Miconic PLUS(+/-)5V, +/-15V 30 AMP
SPC-118		Power Supply, 330A .+5V, +24V, +/-15V 20 AMP
SPC-119	MAP80-4004	Power Supply, Miconic 5, 15, 24V

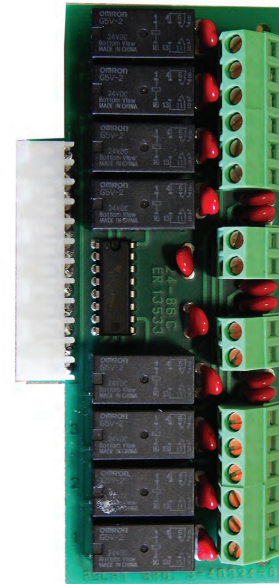

SPC-88



SPC-96



Resistors



WEC-1A



WEC-1J

Adjustable 10" Resistor 200 Watt

S.E.E.S. #	O.E.M. #	Resistance
WEC-1A	X28AS1H01	.72 Ohms
WEC-1D	X28AS1H29	2.0 Ohms
WEC-1E	X28AS1H02	3.4 Ohms
WEC-1F	X28AS1H30	4.7 Ohms
WEC-1G	X28AS1H03	6.4 Ohms
WEC-1H	X28AS1H04	8.5 Ohms
WEC-1J	X28AS1H05	12.6 Ohms
WEC-1K	X28AS1H06	17.0 Ohms
WEC-1	X28AS1H07	21.5 Ohms
WEC-2	X28AS1H08	25.2 Ohms
WEC-3	X28AS1H09	43 Ohms
WEC-4	X28AS1H10	64.2 Ohms
WEC-5	X28AS1H11	84 Ohms
WEC-6	X28AS1H12	126 Ohms
WEC-7	X28AS1H13	168 Ohms
WEC-9	X28AS1H15	455 Ohms
WEC-9A	X28AS1H16	642 Ohms
WEC-10	X28AS1H17	800 Ohms
WEC-11	X28AS1H18	1000 Ohms
WEC-11A	X28AS1H20	1500 Ohms
WEC-12	X28AS1H21	2000 Ohms
WEC-13	X28AS1H22	2500 Ohms
WEC-13A	X28AS1H23	3000 Ohms
WEC-14	X28AS1H24	4000 Ohms
WEC-14A	X28AS1H25	5000 Ohms
WEC-14B	X28AS1H26	6000 Ohms
WEC-14C	X28AS1H27	8000 Ohms



WEC-9A



WEC-14B

S.E.E.S. #	O.E.M. #	Description
WEC-53	K1918G01	Sliding Clip for 1" resistors



WEC-29



WEC-31



WEC-38

Adjustable 5" Resistor 100-160 Watt

S.E.E.S. #	O.E.M. #	Resistance
WEC-29	X28FS1H29	2.0 Ohms
WEC-31	X28FS1H06	17 Ohms
WEC-32	X28FS1H07	21.5 Ohms
WEC-33	X28FS1H08	25.2 Ohms
WEC-35	X28FS1H10	64.2 Ohms
WEC-36	X28FS1H11	84 Ohms
WEC-37	X28FS1H12	126 Ohms
WEC-38	X28FS1H13	168 Ohms
WEC-39	X28FS1H14	252 Ohms
WEC-40	X28FS1H15	455 Ohms
WEC-41	X28FS1H16	642 Ohms
WEC-42	X28FS1H17	800 Ohms
WEC-43	X28FS1H18	1000 Ohms
WEC-44	X28FS1H19	1250 Ohms
WEC-45	X28FS1H20	1500 Ohms
WEC-46	X28FS1H21	2000 Ohms
WEC-47	X28FS1H22	2500 Ohms
WEC-48	X28FS1H23	3000 Ohms
WEC-49	X28FS1H24	4000 Ohms
WEC-50	X28FS1H25	5000 Ohms
WEC-51	X28FS1H26	6000 Ohms
WEC-52	X28FS1H27	8000 Ohms



WEC-44



WEC-53



WEC-45

Relays

ES Relays

Contact Count and Configuration

S.E.E.S. #	O.E.M. #	N.O.	N.C.
WR-1	T9560G34	8 Make	
WR-3	T9560G36	6 Make	2 Break
WR-4	T9560G37	5 Make	3 Break
WR-5	T9560G38	4 Make	4 Break
WR-6	T9560G39	3 Make	5 Break
WR-7	T9560G40	2 Make	6 Break
WR-8	T9560G41	1 Make	7 Break
WR-9	T9560G42		8 Break

■ Coil sold separately.

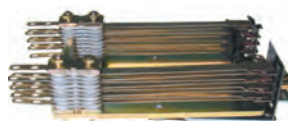

WR-1



WR-4



WR-5



WR-7

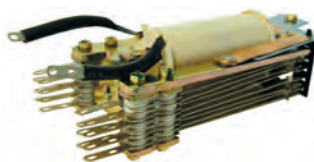

WR-1C



WR-6C

ES Relay & Coil Assemblies

S.E.E.S. #	O.E.M. #	Coil	N.O.	N.C.
WR-1C	324C991G80	125V	8	0
WR-1C2	324C992G80	62.5V	8	0
WR-2C	324C991G71	125V	7	1
WR-2C2	324C992G71	62.5V	7	1
WR-3C	324C991G62	125V	6	2
WR-3C2	324C992G62	62.5V	6	2
WR-4C	324C991G53	125V	5	3
WR-4C2	324C992G53	62.5V	5	3
WR-5C	324C991G44	125V	4	4
WR-5C2	324C992G44	62.5V	4	4
WR-6C	324C991G35	125V	3	5
WR-6C2	324C992G35	62.5V	3	5
WR-7C	324C991G26	125V	2	6
WR-7C2	324C992G26	62.5V	2	6
WR-8C	324C991G17	125V	1	7
WR-8C2	324C992G17	62.5V	1	7
WR-9C	324C991G08	125V	0	8
WR-9C2	324C992G08	62.5V	0	8

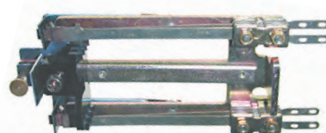

WR-10



WR-13



WR-14



WR-21



WR-15



WR-18



WR-17

EST Time Relays

Contact Count and Configuration

S.E.E.S. #	O.E.M. #	N.O.	N.C.
WR-10	H3056G03	2 Make	
WR-11	H3056G04	1 Make	1 Break
WR-12	H3056G05		2 Break

■ Coil sold separately.

S.E.E.S. #	O.E.M. #	Description
WR-13	K7305G01	Fingerboard, for EC relay
WR-21		Fingerboard, for EST Relays
WR-14	216B711H04 216B711H01	Contact Ladder for ES and EST relays
WR-15	T4483G19	Inductor Switch

Mercury-Wetted Relays

S.E.E.S. #	O.E.M. #	Description
WR-16	145A630H01, HGS1230	For Quota Relay Assembly
WR-18	145A630H02, HGS1021	For DM Inductor
WR-18A	145A630H03, HGS1015	For L3V

S.E.E.S. #	West. #	Description
WR-17	324C981G44	EC Relay with 125V coil and 4 Make, 4 Break contacts

Relay Components

Relays

S.E.E.S. #	O.E.M. #	Description
SR-200	225733	Relay, CRIPHNA 5. QA Socket with Access Relay
SRP-01	NEA462544	Phase Relay, 3 Phase Monitor, 200-600V



SRP-01



WRP-1



WRP-2



WRP-3



WRP-6



WRP-7



WRP-8



WRP-9



WRP-10



WRP-11



WRP-12

S.E.E.S. #	O.E.M. #	Description
WRP-1	M3466G1	Contact and Shunt with silver tip for DS relays, shunt length 6-3/4" x 7/16"
WRP-1A		Contact and Shunt without silver tip for DS relays, shunt length 6-3/4" x 7/16"
WRP-2	K180G05 T3534G8	Contact Assembly with 6" shunt, copper base 5/8" x 2-1/2"
WRP-3	M1230G04	Contact and Shunt Assembly, 4-3/4" L with 1/4" dia. silver tip for KS relays
WRP-4	M1230G05	Contact and Shunt Assembly, 5-1/2" L with 1/4" dia. silver tip for KS relays
WRP-5	M1230G06	Contact and Shunt Assembly, 6-1/2" L with 1/4" dia. silver tip for KS relays
WRP-6	K4277G01	Movable Contact, Heart shaped movable contact for 6B, CR and TC relays
WRP-7	K7310G01	Contact Bridge Assembly for EC control relay
WRP-8	R7533G04	Brake Cooling Contact Assembly with two silver contacts
WRP-9	630B611G01	Stationary Contact for EC control relay, top make or bottom break
WRP-10	630B611G02	Stationary Contact for EC control relay, top break or bottom make
WRP-11	M1230G03	Stationary Contact for 15A, 30V, KS, V and VR relays, 1-1/8" overall with 1/4" diameter silver tip
WRP-12	M1230G20	Stationary Contact for DS relay 7/16" dia. x 1-1/16" tip thread, 13/16" L x 5/32" diameter, 1-1/8" overall

Relay Components

FOR SCHINDLER / WESTINGHOUSE



WRP-13

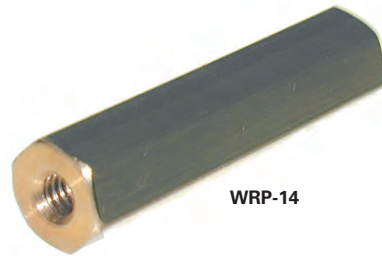

WRP-14

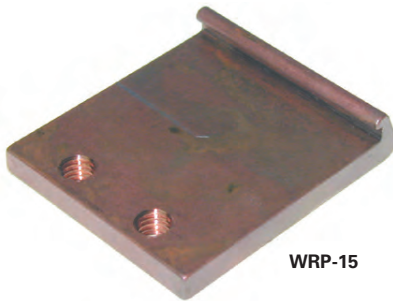

WRP-15

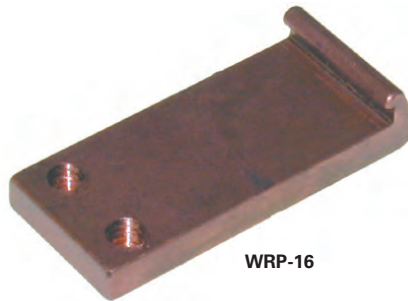

WRP-16



WRP-17

S.E.E.S. #	O.E.M. #	Description
WRP-13	K1809G02	Holder for stationary contact for DS relay
WRP-14	M3467G02	Hex Support for stationary contact for DS relay, hex length 1-13/16"
WRP-15	T1139H07	Copper Contact, 2 x 2-5/16"
WRP-16	T441H09	Copper Contact, 1 x 2-5/16"
WRP-17	P1524H06	Copper Contact, 3/4 x 1-3/4" Screw center to center 7/16"
WRP-18	256956	Copper Contact, 1-1/8" wide
WRP-19	256922	Copper Contact, 3/4" wide
WRP-20	178791	Copper Contact, 5/8" wide
WRP-20A	178791-.50	Copper Contact, angle, 1/2" wide face



WRP-18



WRP-19



WRP-20



Relay Components



WRP-21



WRP-24

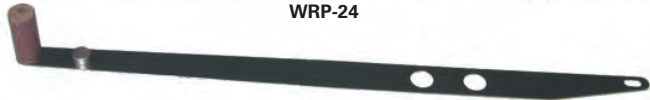

WRP-25



WRP-22C



WRP-29, WRP-27



WRP-30, WRP-28



WRP-31



WRP-31A



WRP-33



WRP-35



WRP-34



WRP-35A



WRP-38

Contact Blades for SRL, SR-1 and STL Relays

S.E.E.S. #	Description
WRP-21	Backup Support Blade, 3-1/8" L without contact
WRP-23	Blade with silver contact and 3/8" phenolic stop
WRP-24	Blade with silver contact, without phenolic stop
WRP-25	Blade with silver tip and phenolic stop on same side
WRP-26	Blade with silver tip and phenolic stop on opposite side
WRP-22A	Spacer, SR, SRL & SN Pile up thin
WRP-22B	Spacer, SR, SRL & SN Pile up medium (.093")
WRP-22C	Spacer, SR, SRL & SN Pile up thick (.125")

Stationary Contacts for 6B, CR and TC Relays

S.E.E.S. #	O.E.M. #	Contact Location	A	B	(Tip) C
WRP-29	X24AS1G01	Outside	2	3-11/16	outside U 1/16
WRP-27	X24AS1G04	Outside	2	2-7/8	inside U 1/16
WRP-30	X24BS1G01	Inside	2	3-3/4	inside U 1/16
WRP-28	X24BS1G02	Inside	2	3-3/32	inside U 1/16

Contact Assemblies for 6B Contactors

S.E.E.S. #	O.E.M. #	Description
WRP-31	M4522G2	Contact with shunt-MAKE
WRP-31A	P-1534-1	Holder & Shunt Assembly
WRP-32	M4522G5	Contact with shunt-BREAK
WRP-33	K4278G01	Contact alone-MAKE
WRP-34	K4278G02	Contact alone-BREAK
WRP-35	X22GS1G04	Shunt for 6B contactors, 6-1/8" L
WRP-35A	X22GS1G01	Shunt for 6B contactors, 1-3/4" L

Contacts for SW Interlocks

S.E.E.S. #	O.E.M. #	Length	Description
WRP-38	K3125G03	3-1/2"	Finger Contact, blade with contact
WRP-36	K3125G01	3-5/8"	Finger Contact, blade with contact
WRP-39	K3125G04	4-3/16"	Finger Contact, blade with contact

Relay Components

S.E.E.S. #	O.E.M. #	Description
WRP-40	K181G2, K181G3	Contact Assembly for 30VS relay, base 1-1/4" x 1/2" with insulated shunt 7" L
WRP-41	K180 series	Contact Assembly , copper base 1/2" x 1-5/8", 2 strand bare copper shunt 4-1/2" L

S.E.E.S. #	O.E.M. #	Description
WRP-42	M4510G1	Base Armature for 6B1 contactor
WRP-43	M4523G1	Base Armature for 6B2 contactor
WRP-44	M4524G01	Base Armature for 6B3 contactor

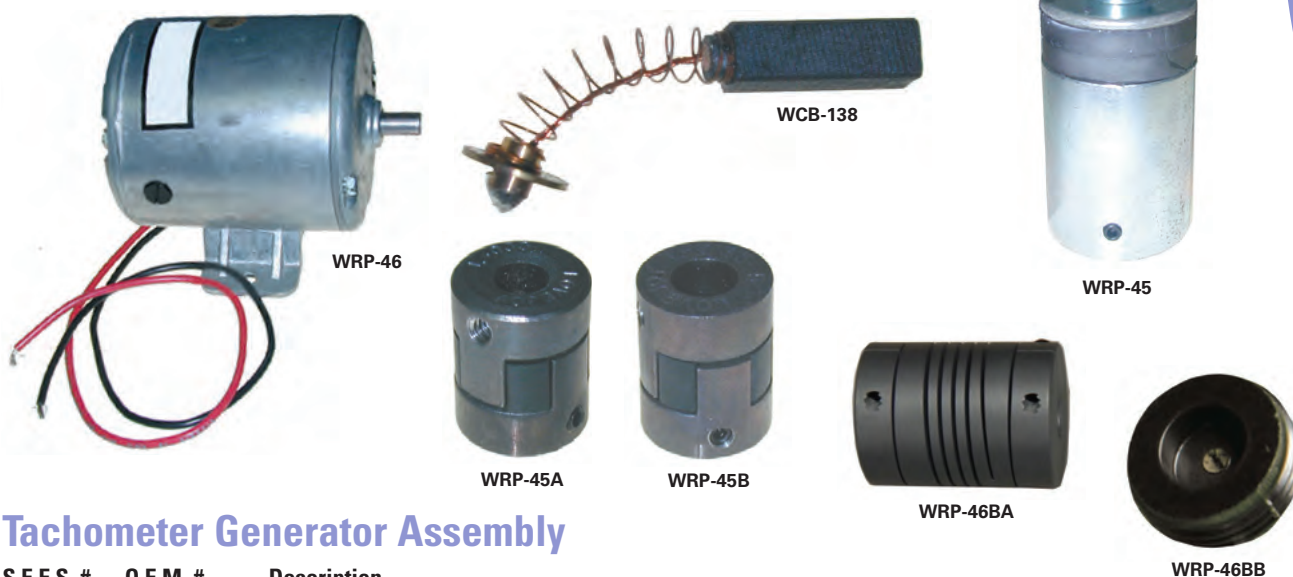
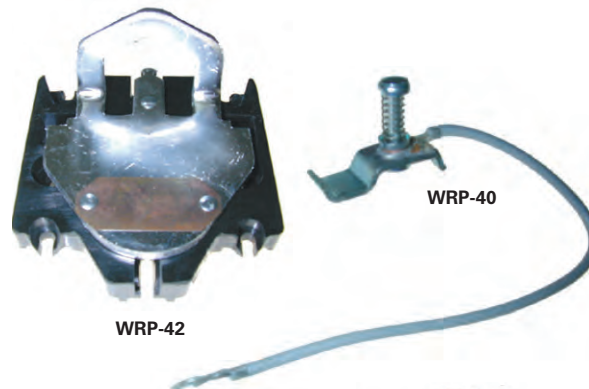

Tachometer Generator Assembly

S.E.E.S. #	O.E.M. #	Description
WRP-46	569A803H01	Motor , Tachometer generator 30 VDC @ 1800 RPM, 15/16" shaft
WRP-46A	198C030H02	Motor , Tachometer generator 60 VDC
WCB-138	569A803H02	Brush for Tachometer generator
WRP-45	103D556G06	Magnetic Coupling for Tachometer
WRP-45A	X49FS1H01	Coupling , flexible, 1/4" to 5/16" coupling
WRP-45B	X49FS1H02	Coupling , flexible, 5/16" diameter
WRP-45M		Magnet , only for WRP-45 (Set of TWO)
WRP-46BA	ACR112-10-10	Coupling , flexible, for WRP-46B
WRP-46BB		Brush Cap , replacement for WRP-46B



S.E.E.S. #	O.E.M. #	Description
WRP-46B	198C030H01	Tachometer , 15 VDC

Starter Contact Kits

S.E.E.S. #	O.E.M. #	Description
WRP-47	373B331G12	Contact Kit , size 2, 3 pole
WRP-48	626B187G13	Contact Kit , size 3, 3 pole
WRP-49	626B187G17	Contact Kit , size 4, 3 pole



Relay Components



WRP-49A



WRP-49B



WRP-52



WRP-53

Components for WL Linestarter

S.E.E.S. #	O.E.M. #	Description
WRP-49A	811C985H06	Contact Kit , size 2, each kit replaces one pole
WRP-49B	811C985H09	Coil , 208-240V

S.E.E.S. #	O.E.M. #	Description
WRP-52	180C138G02	Auxiliary Contact Assembly , 2 normally open contacts, for starter
WRP-53	180C138G01	Auxiliary Contact Assembly , 1 normally open, 1 normally closed contact for L56 interlock

Hatch & Hoistway Equipment



WRP-50



WRP-54B



MIS100K

S.E.E.S. #	O.E.M. #	Description
WRP-50	T9165G04	Safety Switch , RH
WRP-51	T9165G05	Safety Switch , LH

Stepping Switches

S.E.E.S. #	O.E.M. #	Description
WRP-54B	T9165G08	Stepper , Solid State replacement for old style stepping switch
MIS-100K		Stepper Lube Kit of assorted lubricants, specially formulated for maintaining old style stepping switch wear points. Prolongs life, improves performance.

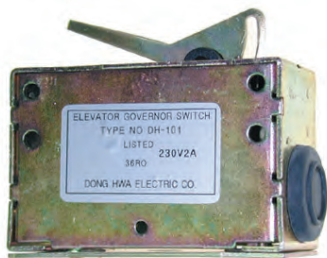

WRP-55

S.E.E.S. #	O.E.M. #	Description
WRP-55	T9165G08	Bi-Directional Governor Overspeed Switch , Type DH101, 230V2A

Hatch & Hoistway Equipment

FOR SCHINDLER / WESTINGHOUSE



WS-1



WS-3



WS-4

Selector Components

S.E.E.S. #	O.E.M. #	Description
WS-1	217B203G01	Switch, Series selector, 1 make
WS-2	217B203G02	Switch, Series selector, 1 break
WS-3	K3233H01	Rubber Coupling for SN selector
WS-4	M1259G03	Brush for type "N" selector
WS-4A		Cam leaf spring replacement for SN selector



WS-4A

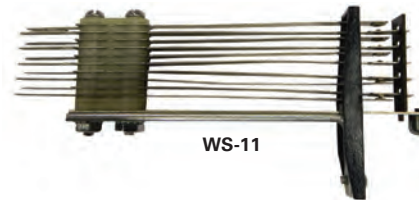

WS-11

Pile-Ups for DM Selector

S.E.E.S. #	O.E.M. #	Description
WS-10	322C830G14	Floor Switch, 4 make 1 break
WS-11	322C830G15	Floor Switch, 3 make 2 break
WS-12	146A990H01	Nylon Cap for DM pile-up



WS-12



WS-14

Lead Screw and Nut for SN Selectors

S.E.E.S. #	O.E.M. #	Description
WS-14	M4699H02	Traveling Nut for selector
WS-14A	569A223H01	Nylon Cap for SN selector
WS-15	X18BS1H02	Bearing for SN selector screw
WS-17	M4700G06	Lead Screw and Nut, 9-15 Floor maximum, 18-5/16" L
WS-17A	M4700G05	Lead Screw Assembly, 8 Floor maximum, 11-5/16" L
WS-17B	M4700G07	Lead Screw Assembly, 16-24 Floor maximum, 27-5/16" L

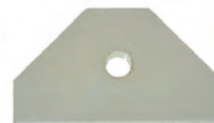

WS-14A



WS-15



WS-17A

Hatch & Hoistway Equipment



WS-6

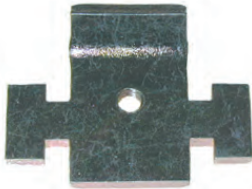

WS-7



SLS-1



SLS-2



WE-2

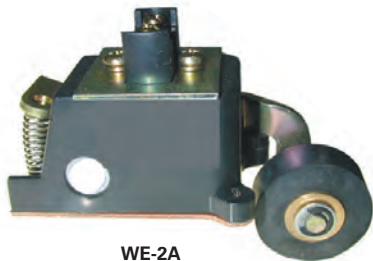

WE-2A

S.E.E.S. #	O.E.M. #	Description
WS-5A		Nylon Tape Guide, with holes
WS-5AB		Tape Guide, heavy duty brass, for IP8300
WS-5A-INSERT		Insert for Tape Guide
WS-6	145A111H01	Tape Guide, Short Clip, for WS-5/5A
WS-7	145A111H02	Long Clip, with radius bend
GS-3	GALX-0307N	Tape Guide, for GAL Selector



WS-5A



WS-5AB

Limit Switches

S.E.E.S. #	O.E.M. #	Description
SLS-1	418482	Latching Reed Switch, Leveling Used For Schindler KE8 Lev Assembly
SLS-2	1319B05H01	Magnetic Reed, Switch Assembly
SLS-4	KE8-U	For Schindler Limit Switch Kit, 8 Switch Unit
SLS-4A	3-40022-15	For Schindler Limit Switch Mounting Square Nut for KE8 and KE14
SLS-5	KE14-U	For Schindler Limit Switch Kit, 14 Switch Unit
WE-2	321C201G01	Hatch Limit Switch, normally closed
WE-2A	321C201G02	Inching Switch, N.O.

Type E Landing Switch

S.E.E.S. #	O.E.M. #	Description
WS-8A	324C969G04	Switch, 1 make 1 break
WS-8B	324C969G03	Switch, 2 make
WS-8C	324C969G07	Switch, 1 break
WS-8D	324C969G06	Switch, 1 make
WS-8E	324C969G05, 324C969G08	Switch, 2 break

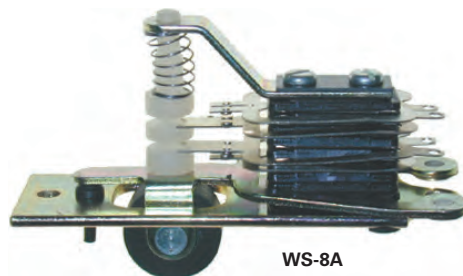

WS-8A

Hatch & Hoistway Equipment

S.E.E.S. #	O.E.M. #	Description
WS-16	145A742G01	Advancer Take-Up Roller
WS-16A	145A741G01	Advancer Take-Up Roller
WS-18	216B311G02	Cam, 5-1/2" with hardware
WS-19	216B311G03	Cam, 8" with hardware
WS-20	216B311G04	Cam, 19" with hardware
WS-21	216B311G01	Cam, 3" with hardware
WS-22	5061A04H02	Beam Switch, leveling



WS-16



WS-16A



WS-18



WS-20



WS-21



WS-22

S.E.E.S. #	O.E.M. #	Description
SCSW-1		Switch, Security Windows
SCSW-2		Switch, for Landing Door
SCSW-3	332969	Switch, UKT Automatic Reset
SCSW-4	292798	Switch, UKS



SCSW-1



SCSW-2



SCSW-3



SCSW-4

TRACTION MOD GOT YOU TIED DOWN?

THE ELECTRONIC UPGRADE FOR OLD-STYLE MECHANICAL SWITCHES

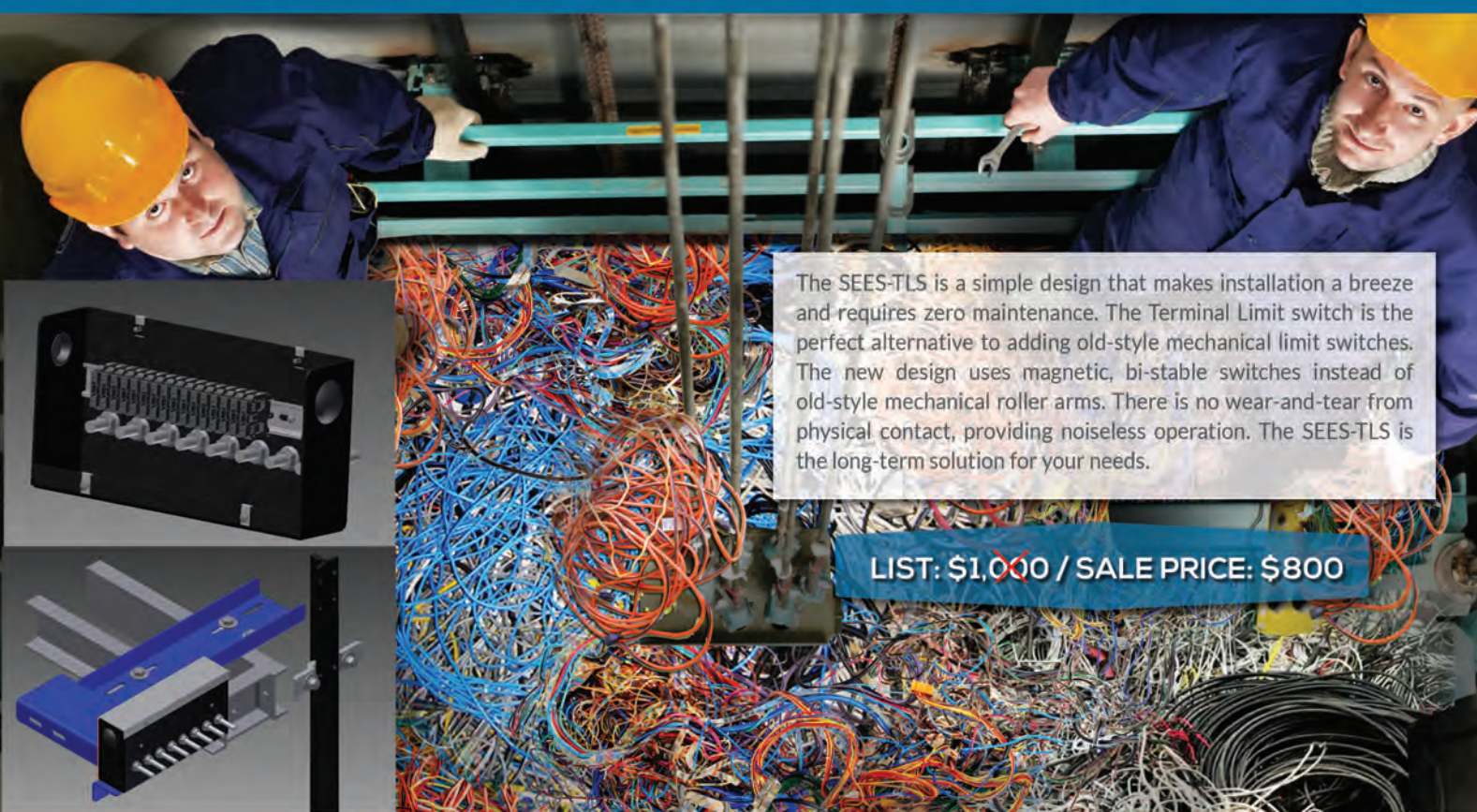

The SEES-TLS is a simple design that makes installation a breeze and requires zero maintenance. The Terminal Limit switch is the perfect alternative to adding old-style mechanical limit switches. The new design uses magnetic, bi-stable switches instead of old-style mechanical roller arms. There is no wear-and-tear from physical contact, providing noiseless operation. The SEES-TLS is the long-term solution for your needs.

LIST: ~~\$1,000~~ / SALE PRICE: \$800

HOW IT WORKS

The switch assembly is mounted to the car top using our universal brackets system. The magnetic switches are arranged so that they interact with rail-mounted magnets in the hoistway, providing the two-way signal for the controller.

MAINTENANCE FREE

The SEES Terminal Limit Switches are tested, dependable, and have no moving parts, making them virtually maintenance-free and ultimately reducing call-backs.

EASY TO INSTALL

- Easy installation using universal bracket system
- Eliminates the need for hoistway wiring
- No adjustments after initial installation
- Reduced Installation cost
- No moving parts

Installation is a breeze and no maintenance is required!

FREE WITH PURCHASE OF SEES-TLS!



GET BOTH FREE WITH THE PURCHASE OF A SEES-TLS!!
A \$55.00 VALUE

SEES-JUMPER-001
SEES-TOOL-002

MANY USES

- Perfect for modernization projects
- Terminal slowdown
- Access limit switch
- Speed limiting
- Emergency terminal stopping

ADVANTAGES

- Easy to follow instructions
- Non-contact, noiseless operation
- Durable and accurate magnetic switching
- Best value and low cost installation

By Phone:
800.526.0026
954.971.1115

By Fax:
954.917.7337
Visit Us: www.SEEInc.com



Always Smooth Sailing

Transformers

S.E.E.S. #	O.E.M. #	Description
WTR-2	325C827H02	Transformer, 300VA, PV: 230/460
WTR-3	320C940H02	Transformer, 550VA, PV: 400, SV: 101 taps
WTR-4	630B480H01	Pulse transformer
WTR-5	692B253H01	Transformer, 600VA, PV: 208/230/460, SV: 115/230
WTR-6	144A212H01	Transformer, 5VA, PV: 110/115, SV: 15V
WTR-7	320C940H01	Transformer, 550VA, PV: 200/260, SV: 101V
STR-001	5058A18H01	Transformer, 350 VA P = 230/460, S = 115/160
STR-002	198C033H01	Transformer, 550 VA, P = 230/460, S = 115/160



WTR-2



WTR-3



WTR-4



WTR-5



WTR-6



WTR-7



STR-001

Wheels

Type B3M Hanger Assemblies

S.E.E.S. #	O.E.M. #	Description
WW-1	T5411G99	Hanger Assembly, 3-3/8" OD, complete for flat track
WW-1R	T5411G99-Round	Hanger Assembly for Round Track 3-3/8", Individual
WW-2	R8858G01	Hanger Roller, 3-3/8" diameter, aluminum with polyurethane tire
WW-1A	R8858G01	Hanger Assembly, Less Roller, requires WW-2 roller
WW-10	152B011G02	Steel Upthrust Roller for above, 31/32" OD x 7/16" W



WW-1



WW-1R



WW-10



Wheels



WW-4

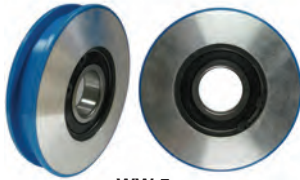

WW-5

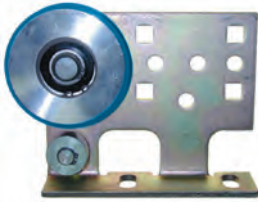

WW-7RH

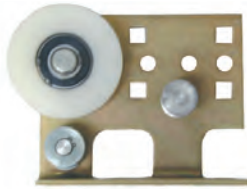

WW-7RH-NYLON



WW-10

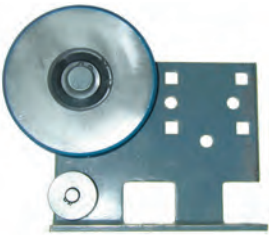

WW-11RH



WW-14LH-P

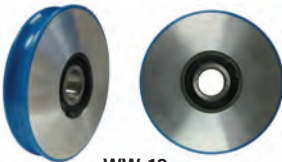

WW-12



WW-12N

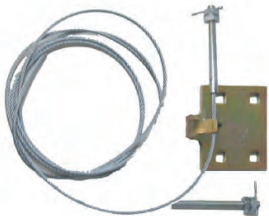

WDO-60F

Type A3M Hanger Assemblies

S.E.E.S. #	O.E.M. #	Description
WW-4	T5409G99	Hanger Assembly complete
WW-5	R8636G98 R8636G01	Hanger Roller , 4-3/8" diameter, 1-1/8" bearing, aluminum with polyurethane tire, fits square rail
WW-6	M6029G01	Steel Upthrust Roller for above 1-3/8" diameter x 7/16" wide

Type ACD/ACN Hanger Assemblies

S.E.E.S. #	O.E.M. #	Description
WW-7RH	M7405G99	Hanger Assembly complete, RH with WW-18
WW-7LH	M7405G99	Hanger Assembly complete, LH with WW-18
WW-7RH-NYLON	M7405G3, G5	Hanger Assembly complete, RH with WW-17 nylon roller
WW-7LH-NYLON	M7405G4, G6	Hanger Assembly complete, LH with WW-17 nylon roller
WW-17	576B535G04	Hanger Roller 2-3/4" diameter, nylon roller
WW-17A		Roller , Nylon 2-3/4" OD x.6693" bore, 6203 bearing
WW-18	576B535G98	Hanger Roller 2-3/4" diameter, aluminum with polyurethane tire
WW-10	152B011G02	Steel Upthrust Roller for above 31/32" diameter x 7/16" wide

Type AC2 Hanger Assemblies

S.E.E.S. #	O.E.M. #	Description
WW-11RH	324C083G99	Hanger Assembly complete, RH
WW-11LH	324C083G99	Hanger Assembly complete, LH
WW-6	M6029G01	Steel Upthrust Roller for above 1-3/8" diameter x 7/16" wide
WW-14LH-FS	W-408L	Hanger Assembly , E4 LH with Fire Stop
WW-14RH-FS	W-408R	Hanger Assembly , E4 RH with Fire Stop
WW-14LH-P	W408L-POLY	Hanger Assembly LH with Poly Roller
WW-14RH-P	W408R-POLY	Hanger Assembly RH with Poly Roller
WW-14LH-PR	W408L-POLY-R	Hanger Assembly LH with Poly Roller, Reversed (Backside)
WW-14RH-PR	W408R-POLY-R	Hanger Assembly RH with Poly Roller, Reversed (Backside)
WW-12	323C235G02	Hanger Roller , 4-1/4" diameter, 6204" bearing .7874" ID, aluminum with polyurethane tire
WW-12N	323C235G01	Roller , Nylon 4-1/4" OD with .7874" ID
WDO-60F	144A883G01	Cable Assembly includes WDO-60D and E

Wheels

Type ACA Hanger Assembly E4 Entrances

S.E.E.S. #	O.E.M. #	Description
WDO-60G	682A139H02	Door Roller Stud, 1.360AL, 1/2-20 thread
WDO-60I	569A700H01	Cinch Nut, 1/2-20 Shoulder for Hanger Roller
WHDW-001	569A753H01	Spacer Washer, for Hanger Roller
WW-14RH	325C798G01	Hanger Assembly complete, RH
WW-14LH	325C798G02	Hanger Assembly complete, LH
WW-14S		Stud Mounting for Hanger Bracket, Requires Peening in Place
WW-14S-N		Nut for WW-14S, 1/2-20 Wedge Nut
WW-15	325C798G09	Aluminum Roller, 2-3/4" diameter
WW-15A		Aluminum Roller, 2-3/4" diameter .600" thick
WW-15P	W-408W1-POLY	Hanger Roller, Alum with Poly 2-3/4" OD for WW-14LH/RH-P
WW-16	325C798G10	Upthrust Roller for above 1.00" dia x 7/16" wide



WDO-60G



WDO-60I



WHDW-001



WW-14LH



WW-14S-N



WW-15P



WW-15



WW-15A



WW-16

Hanger Assemblies

S.E.E.S. #	Description
SCHR-2A	Hanger Assembly, 1.57" x .35", 40mm x 9mm Straight Bracket only
SCHR-2B	Hanger Assembly, 1.57" x .35", 40mm x 9mm Straight Bracket with Hardware
SCHR-3A	Hanger Assembly, 1.57" x .35", 40mm x 9mm Offset Bracket
SCHR-3B	Hanger Assembly, 1.57" x .35", 40mm x 9mm Offset Bracket, with Counter Sunk Holes



SCHR-3B

Track Liner

S.E.E.S. #	O.E.M. #	Description
WDO-65	569A844H01	Nylon Track Liner, sold in 12 ft. length or cut to your specifications
WDO-65A	569A844H0110	Nylon Track Liner, sold in 10 ft. length
WDO-65B	569A844H01-8	Nylon Track Liner, sold in 8 ft. length
WDO-65B-SS		Track Liner, stainless steel, 99" Long with hardware
WDO-65C		Track Liner, 6' sections
WDO-65C-SS		Track Liner, stainless steel, 74" Long with hardware
WDO-65D-SS		Track Liner, S/S, 92" Long with Hardware
WDO-65E-SS		Track Liner, S/S, 42" Long with Hardware
WDO-65-SPECIAL		Nylon Track Liner, specify length

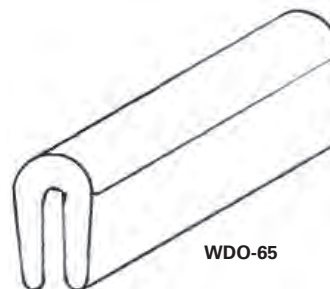

WDO-65

Wheels

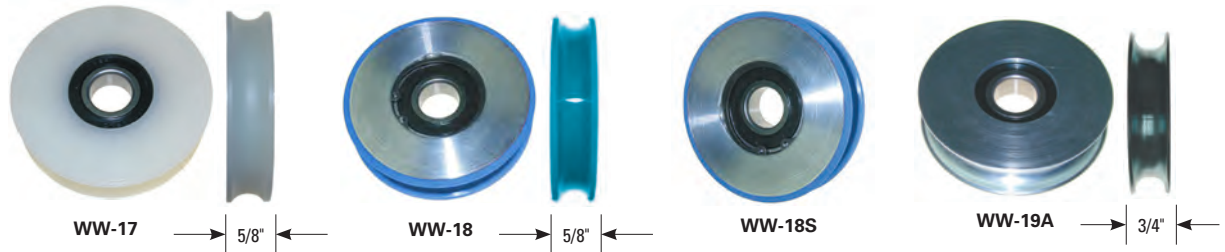

S.E.E.S. #	O.E.M. #	Description
WW-17	576B535G04	Nylon Roller , 2-3/4" dia., .5906" ID
WW-18	576B535G98	Aluminum Roller with polyurethane tire, 2-3/4" dia., .5906" ID
WW-18S	576B535-G98	Hanger Roller , 2-3/4" Steel with poly, .5906" ID
WW-19A	7266C866G01	Steel Hanger Roller , 3" dia.
WW-20	144A277G01	Roller Guide Wheel , 3" dia., .6693" ID, 1" thick
WW-20A	144A277G02	Roller Guide Wheel , 3" .6693 bore, steel hub
WW-20AA	144A28H01	Bushing , Side bushing for 3" Roller Guide (465D274G02)
WW-20AH		Roller Guide Wheel , 3" .6693 bore, steel hub, hard poly
WW-20BB	144A28H02	Bushing , Face bushing for 3" Roller Guide, assembly WRG-005 (465D274G02)
WW-20-S		Post Shaft for WW-20 roller
WW-20-SS		Shaft , for side roller on WRG-005/6
WW-21	323C160G01 323C160G02	Roller Guide Wheel , 6" dia., tire face 13/16", .6693", ID, double bearing
WW-21A	M5594G02	Roller Guide Wheel , 4-1/2" OD, 1-1/4" thick with polyurethane tire, tire face 13/16", bearing .6693" ID, double bearing
WW-21AH	M5594G02	Roller Guide Wheel , 4-1/2" OD x 1-1/4" W .6693 ID, HD 90 Duro
WW-21B	M5594G04 M5594G05 M5594G01	Roller Guide Wheel , 3-1/2" dia. with polyurethane tire, tire face 5/8", bearing .6693" ID, double bearing
WW-23	M5594G03	Roller Guide Wheel , 10-1/4" dia., .6693" ID
WHDW-001		Spacer Washer , for Hanger Roller

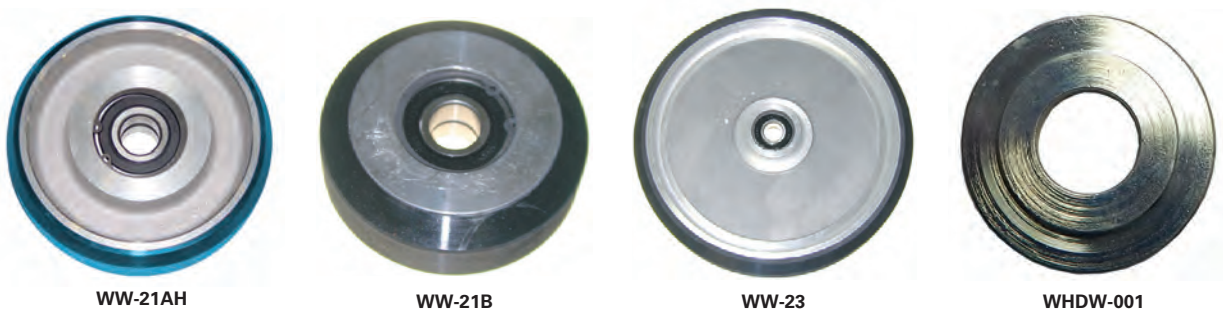

S.E.E.S. #	O.E.M. #	Description
SCGS-2		Guide Shoe Insert , for Counter Weight 150mm x 30 mm x 10mm
SCGS-3		Guide Shoe , for L10 Counter Weight
SCGS-4		Guide Shoe Insert , for 300P 101mm x 10mm Rail
SCGS-5		Guide Shoe Insert , for 300P 101mm x16mm Rail
SCGS-6		Guide Shoe Insert , for Counter Weight 150mm x 30mm x 16mm
SCGS-10		Guide Shoe , for L7
SCGS-11		Guide Shoe Insert , for T22 220mm x 10/16mm
SCGS-12		Guide Shoe , for Counter Weight, 16mm Rail
SCGS-13		Guide Shoe Head , for Counter Weight
SCGS-14		Polyurethane Sliding Rail
SCGS-18	693B180H01 7029C76H01	Guide Shoe Insert , Side For Assembly
SCGS-19	693B476H02	Guide Shoe Insert , 330A Nylon
SCGS-23		Polyurethane Sliding Rail



SCGS-2



SCGS-3



SCGS-4



SCGS-5

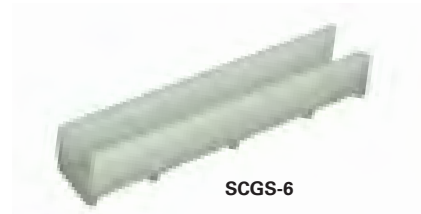

SCGS-6



SCGS-10



SCGS-11



SCGS-12



SCGS-13



SCGS-19



Wheels



WRG-001



WRG-001A



WRG-002

S.E.E.S. #	O.E.M. #	Description
WRG-001	627D989G08	Roller Guide Assembly, 6" roller 8-16# Car Rail, uses WW-21 Rollers
WRG-001A		Adaptor Plate, WRG-001 to URG-002 (Also WRG-004)
WRG-002	465D274G01	Roller Guide Assembly, 3" roller 8-16# CWT Rail, uses WW-20 Rollers
WRG-003	627D989G03	Roller Guide Assembly, 4.5" + 6" roller 8-16# CWT Rail
WRG-004	627D989G05	Roller Guide Assembly, 6" roller 16# CWT Rail
WRG-005	465D274G02	Roller Guide Assembly, 3" roller 8-16# Car Rail
WRG-006	465D274G03	Roller Guide Assembly, 3" roller replacement
WRG-007	627D989G04	Roller Guide Assembly, 4.5" & 6" Roller, 18.5# CWT Rail
WW-20BB		Bushing, face bushing for 3" roller guide (465D274G02)
WW-20-SS		Shaft, for side roller on WRG-005/6



WRG-003

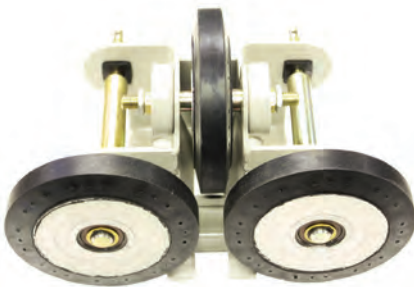

WRG-004



WRG-005



WRG-006



WRG-007

Rollers

S.E.E.S. #	O.E.M. #	Description
WW-24	151B452G01	Terminal Motion (T.M.) Roller Assembly Kit , 4" OD, 13/16" wide, bearing .6693" ID
WW-24A		Roller , 4" OD, alone for WW-24
WW-24-XHDW-KIT		Hardware Kit , for WW-24
WW-25	M1821G01	Roller , alone for Type "S" Limit Switch
MW-8	694B995H01	Door Roller , 3.7" OD, 1.573" ID, 3-11/16" bearing
WW-28	694B995H01	Roller , For EZ-Oper 3-1/4" OD with stud
WW-21C	K5212H05	Face Bushing , polyurethane, 2-1/4" OD, .875" ID for shaft WW-21F, .600" W. One per assembly
WW-21C-A	K5212-2	Face Bushing , for roller guide 2-1/4" OD, 13/16" ID x 1" Thick
WW-21D	144A237H02	Side Bushing , polyurethane, 2-1/4" OD, 1/2" ID for shaft WW-21G .625" W. Two per assembly
WW-21D-A	144A237H01	Side Bushing , for roller guide 2-1/4" OD, 1/2" ID x 1" Thick
WW-21E	144A233H01	Rubber Washer , for roller guide wheel assembly
WW-21F	146A988H01	Shaft , only, for face roller WW-21, WW-21A, and WW-21B roller guide wheel assemblies
WW-21G	576B701H01	Shaft , only, for side roller WW-21, WW-21A, and WW-21B roller guide wheel assemblies
WW-21H	144A237H03	Bushing Assembly , Side post with urethane bumper
WW-21J		Shaft Retainer , with Hardware, Set of two
WHDW-001	569A753H01	Washer , Shoulder Spacer, used on hanger roller



WW-24

WW-25



WW-21C

WW-21C-A

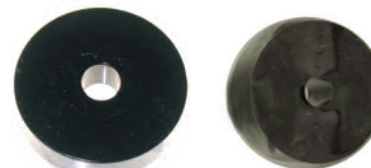

WW-21D

WW-21D-A



WW-21E

WW-21F

WW-21G

WW-21H



SCDV-3

SCGS-15

S.E.E.S. #	Description
SCDV-3	Roller , for Door Lock 26mm x 14mm ID: 9
SCGS-15	Roller , for Guide Shoe 150mm x 30mm x 2mm, bearing 6201 ID: 12
SCGS-16	Roller , for Guide Shoe 100mm x 25mm, bearing 6205 ID: 25
SCGS-17	Guide Shoe Insert , Face For The Square Tube Rail
SCHR-1	Roller , for Hanger, OD 76mm
SCHR-2	Roller , for Hanger, 75mm x 12mm, straight panel
SCHR-3	Roller , for Hanger, 75mm x 12mm
SCHR-7	Roller , for Hanger 54mm x 18mm GD: 48, bearing 6200 ID: 10
SCHR-8	Roller , for Hanger for AD9 72mm x 15mm GD: 64, bearing 6200
SCHR-9	Roller , Retaining for Hanger for 300P 34mm x 19mm GD: 28
SCHR-11	Roller , for Hanger 54mm x 20mm GD: 48, bearing 6200 ID: 10
SCHR-051	Upthrust , Eccentric with 6203Brg 5/8-18 Thrd
SCLO-2	Roller , for Door Lock 31mm x 21mm ID: 14
SCLO-3	Roller , for V30 Door Lock 30mm x 15mm ID: 12
SCLO-14	Roller , for Door Lock 31mm x 21mm ID: 12
SCWH-17	Roller Assembly , sheave support plate
SCWH-19	Guide Roller
SCWH-20	Roller , 76mm x 25mm, 6204
SCWH-20B	Anti-Static Roller , 98mm x 30mm



SCGS-16

SCHR-1

SCHR-2

SCHR-3

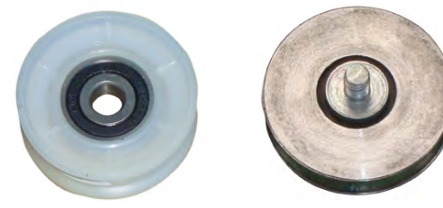

SCHR-7

SCHR-8



SCHR-11

SCLO-2

SCLO-3

SCWH-17

SCWH-20

Ohms Law Pie Chart

This "Ohms Pie Chart" is a wonderful tool in determining what formula to use during calculations for the various components of a circuit.

Example:

To find power in watts, place your finger over the P and reference the formula, I R. So $P=I R$.

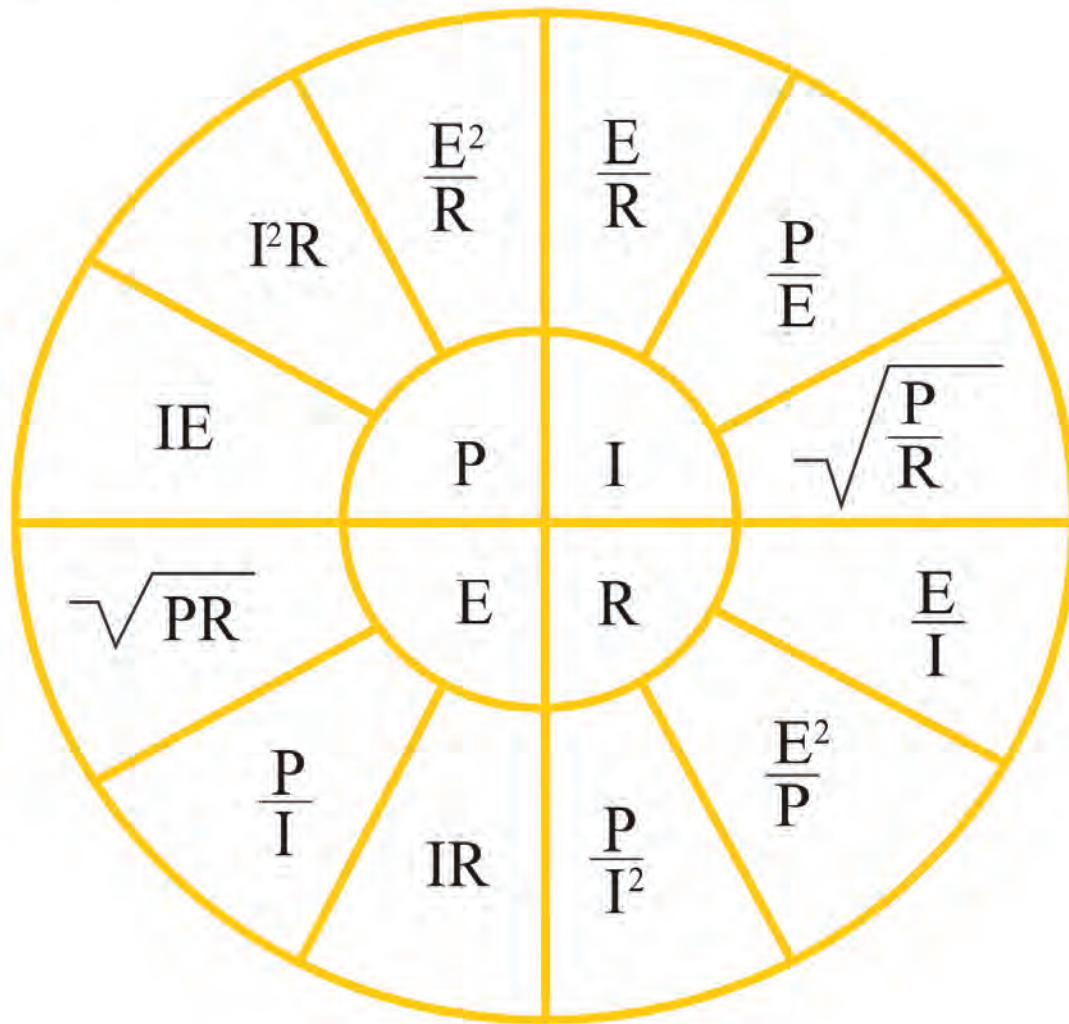

In order to determine the third component you must know two of the components. The above chart is for DC power; for AC power the power factor PF must be included.

Courtesy of ELEVATOR WORLD, INC., from Elevator Maintenance Manual. Copyright © 1999. Reprinted by permission.