

TABLE OF CONTENTS

Car Signal Components

Pushbutton Assemblys	608
Stop Switches, Contact Blocks DMG, Soft Touch	609
Lantern and Hall Station Plates – Arrows and Diffusers	610
Position Indicator Assembly and Components	611
Gongs, Capacitors	611
Key Switches.....	612
Bezels	613
Fuses	613
Lamps	613
Printed Circuit Boards and Timers	614-615
Relays	615-616
Resistors	617
Transformers	617
Seals	618
Valve Kits	618
Pump Belts	618
Contact Kits	618
Hatch Equipment	619
Limit Switches	619
Guide Shoe Inserts	619
Tape Guides	619
Wheels and Roller Guide Assemblies	620

Car Signal Components

SN



1



7



9

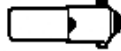

10



11



1
(1-1/4" dia.)



6



7

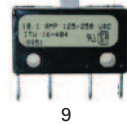

9



11

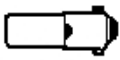

10



2



3



4



5

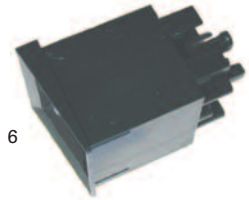

6

Square Pushbutton Assembly

Item	S.E.E.S. #	O.E.M.#	Description
1	US-B32A	167-03017-100	Pushbutton assembly complete , square black housing, 167-03010-100 white button insert, specify marking: i.e. US-B32A-Door Open
2	US-B14	467-01006-007	Clear Cap , square plastic button cap
3	US-B23-	467-01012-007	Insert , square white button insert, specify marking i.e. US-B23-Door Open
4	US-B19	467-01005-007	Body , square white molded plastic button body
5	US-B25	920-36001-000	Spring 1/2" x .088" O.D. x .010" (4 required/assy.)
6	US-B20	467-01001-007	Housing , square black molded plastic button housing
7	US-B22A	167-02014-700	Clamp , pushbutton "L" clamp
8	US-B22B		Clamp , pushbutton "U" clamp
9	US-B26	467-00026-007	Micro switch licon subminiature
10	ML-8	930-27004-000	Lamp , 60 MB, 60 V
11	US-B24	940-31001-000	Lamp socket mini bayonet .575" O.D.
	US-B19C	167-03014-002	Spacer , clear, for square button, to California code

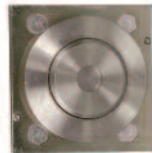

US-B40-BLANK-VAN



2



3



4

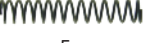

5

Round Pushbutton Assembly

Item	S.E.E.S. #	O.E.M.#	Description
1	US-B40	167-03011-100	Pushbutton Assembly complete , round black housing, white button insert, specify marking, i.e. US-B40-Alarm
	US-B40-BLANK-VAN		Push Button Assembly , vandal proof, stainless steel standard round version
2	US-B38	467-05006-007	Clear cap , round plastic button cap
3	US-B23A-	467-01012-007	Insert , round white button insert, specify marking i.e. US-B23A-Alarm
4	US-B39	467-05005-007	Body , round white molded plastic button body
	US-B39C	167-03014-001	Spacer for round button, California code
5	US-B25	920-36001-000	Spring 1/2" x .088" O.D. x .010" (4 required/ assy.)
	US-B25A		Spring , heavy-duty, 1/2" fire service switch, California code
6	US-B37	467-05001-007	Housing , round black molded plastic button housing
7	US-B22A	167-02014-700	Clamp , pushbutton "L" clamp
8	US-B22B		Clamp , pushbutton "U" clamp
9	US-B26	467-00026-007	Microswitch licon subminiature
10	ML-8	930-27004-000	Lamp , 60 MB, 60V
11	US-B24	940-31001-000	Lamp socket mini bayonet .575" O.D.

Car Signal Components

Stop Switches

S.E.E.S. #	O.E.M.#	Description
US-B15A	167-03012-100	Stop Switch Assembly , Square black molded plastic housing with red insert marked "PULL-EMERGENCY-STOP"
US-B15B	167-03013-100	Stop Switch Assembly , Round black molded plastic housing with red insert marked "PULL-EMERGENCY-STOP"
US-B15C	467-05010-007	Button , round, and actuator for stop switch assembly US-B15B
US-B15D	467-05008-007	Mount , for stop switch assembly US-B15B
US-B16	467-01003-007	Housing , Square, black stop switch housing for US-B15A
US-B17	167-02013-700	Arm Actuator assembly, Includes: Body, Insert and Clear Cap
US-B18	467-00002-007	Toggle Switch , for US-B15A and US-B15B
US-B23-STOP	467-01012-007	Insert for Square Emergency Stop Switch, red insert marked "Pull Emergency Stop"
US-B23A-STOP	467-05012-007	Insert for Round Emergency Stop Switch, red insert marked "Pull Emergency Stop"

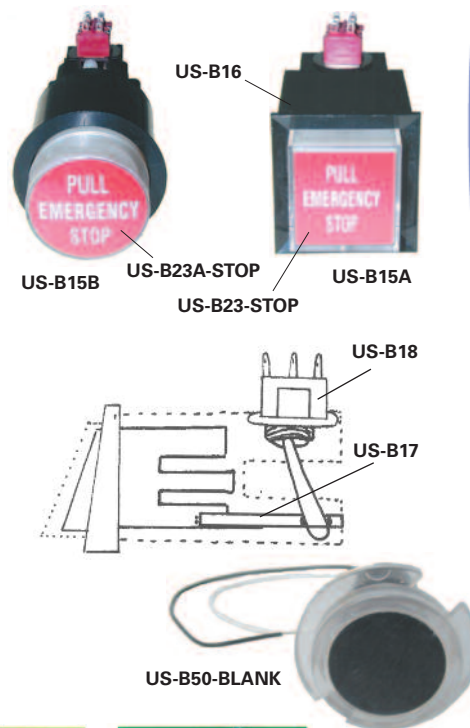

Contact Blocks

S.E.E.S. #	Description
US-B50A	Contact Block , Pushbutton Non-Illuminated DMG
US-B50B	Contact Block , 110V PB Blue Illumination DMG
US-B50C	Contact Block , 110V PB Red Illumination DMG
US-B50D	Contact Block , 12V PB Blue Illumination DMG
US-B50E	Contact Block , 12V PB Red Illumination DMG
US-B50F	Contact Block , 24V PB Blue Illumination DMG
US-B50G	Contact Block , 24V PB Red Illumination DMG
US-B50H	Contact Block , 24V PB Green Illumination DMG
US-B50I	Contact Block , 24V PB Amber Illumination DMG
US-B50J	Contact Block , 6V PB Blue Illumination DMG
US-B50K	Contact Block , 6V PB Red Illumination DMG
US-B50L	Contact Block , 6-120Volt PB Blue Illumination DMG
US-B50M	Contact Block , 6-120Volt PB Red Illumination DMG

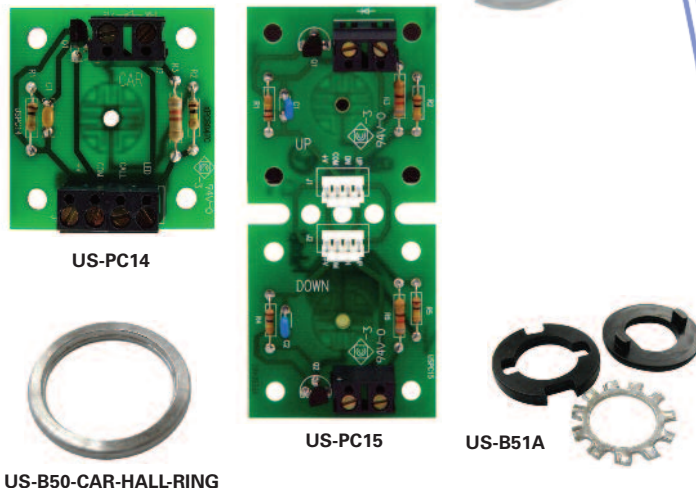

"Soft Touch" Button

S.E.E.S. #	O.E.M.#	Description
US-B50-BLANK	166-01020-702, 166-10034-100	Button assembly, Soft Touch Style, 24VDC if used in series, 48VDC if used alone, blank
US-PC14	146-05054-300	P.C. Board , for car, used on Soft Touch series
US-PC15	146-05055-300	P.C. Board , for hall, used on Soft Touch series
US-B50-CAR-HALL-RING		Soft Touch, Car/Hall Ring , vandal proof, tough metal
US-B50-CAR		Pushbutton Assembly , complete for car
US-B50-HALL		Pushbutton Assembly , complete for hall
US-B50-ALARM		Pushbutton Assembly , marked "Alarm"
US-B51A		Adapter Kit , for US-B51 key switch mount



Car Signal Components

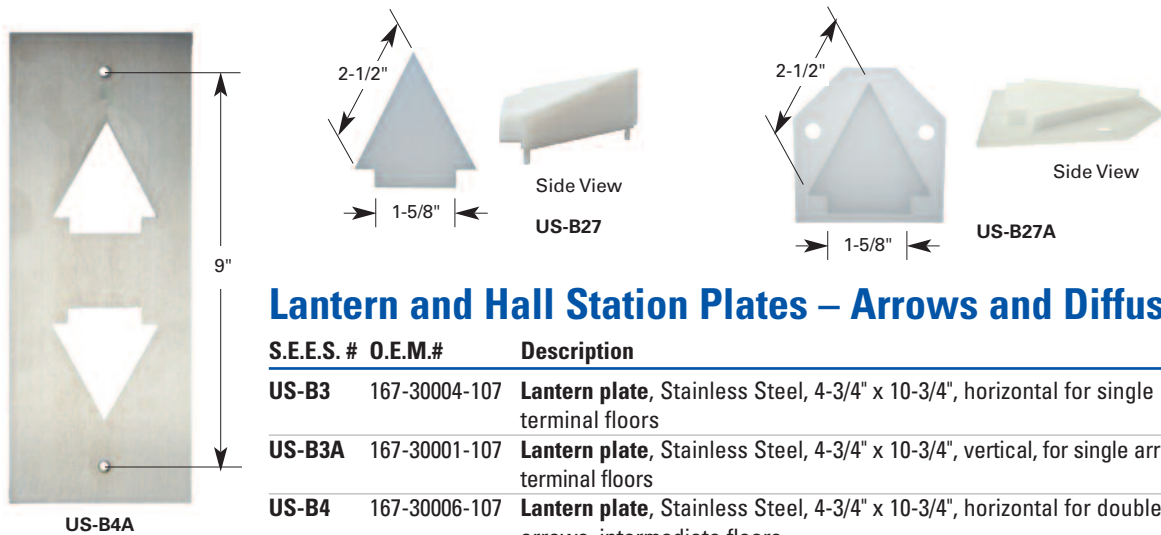

Lantern and Hall Station Plates – Arrows and Diffusers

S.E.E.S. #	O.E.M.#	Description
US-B3	167-30004-107	Lantern plate, Stainless Steel, 4-3/4" x 10-3/4", horizontal for single arrow, terminal floors
US-B3A	167-30001-107	Lantern plate, Stainless Steel, 4-3/4" x 10-3/4", vertical, for single arrow, terminal floors
US-B4	167-30006-107	Lantern plate, Stainless Steel, 4-3/4" x 10-3/4", horizontal for double arrows, intermediate floors
US-B4A	167-30003-107	Lantern plate, Stainless Steel, 4-3/4" x 10-3/4", vertical for double arrows, intermediate floors
US-B5	167-30002-107	Lantern plate, Stainless Steel, 3-3/4" x 10-3/4", vertical for double arrows, intermediate floors
US-B27	467-00012-007	Arrow, extruded large plastic, 2-1/2" sides, 1-5/8" base, 3 mounting pins on back
US-B27A	467-00028-007	Lens, white flat lantern arrow on plastic mounting base
US-B28	167-03004-700	Diffuser, green, for lantern arrow for US-B27A
US-B29	167-03003-700	Diffuser, red, for lantern arrow for US-B27A

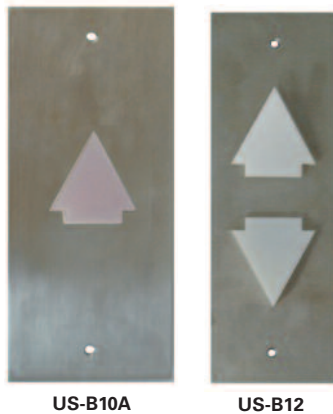

US-B10A

US-B12



US-B9



US-B11

S.E.E.S. # Description

US-B9	Lantern plate, Stainless Steel, 4-3/4" x 10-3/4", Horizontal, Terminal Green
US-B9A	Lantern plate, Stainless Steel, 4-3/4" x 10-3/4", Horizontal, Terminal Red
US-B10	Lantern plate, Stainless Steel, 4-3/4" x 10-3/4", Vertical, Terminal Green
US-B10A	Lantern plate, Stainless Steel, 4-3/4" x 10-3/4", Vertical, Terminal Red
US-B11	Lantern plate, Stainless Steel, 4-3/4" x 10-3/4", Horizontal, Inter. Complete
US-B12	Lantern plate, Stainless Steel, 4-3/4" x 10-3/4", Vertical, Inter. Complete
US-B13	Lantern plate, Stainless Steel, 3-3/4" x 10-3/4", Vertical, Inter. Complete

■ All parts use US-B27.

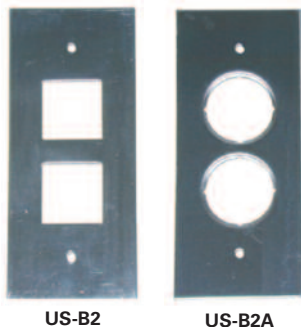

US-B2

US-B2A

S.E.E.S. # O.E.M.# Description

US-B1	167-61001-107	Hall plate, Stainless Steel, 3" x 7", single square hole, for terminal floors
US-B1A	167-65001-107	Hall plate, Stainless Steel, 3" x 7", single round hole, for terminal floors
US-B2	167-61003-107	Hall plate, Stainless Steel, 3" x 7", double square holes, for intermediate floors
US-B2A	167-65003-107	Hall plate, Stainless Steel, 3" x 7", double round holes, for terminal floors

Car Signal Components

Position Indicator Assembly

S.E.E.S. #	O.E.M.#	Description
US-B32A-PI*	167-03017-100	Square P.I. assembly w/ black housing, specify marking
US-B24A	940-31002-000	Socket .575" O.D. with clip
US-B40-PI*	167-03011-100	Round P.I. Assembly, black housing, specify marking

* Micro switch not used on these assemblies

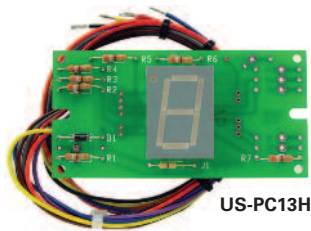

US-PC13H

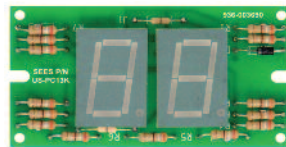

US-PC13K

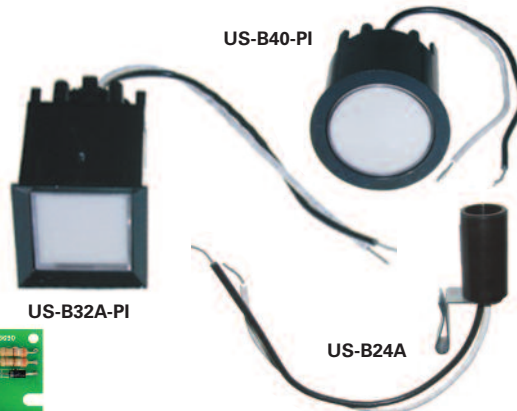

US-B32A-PI

US-B40-PI

US-B24A

Digital Position Indicator Components

S.E.E.S. #	O.E.M.#	Description
US-PC13G	154-05006-301	P.C. board for vertical Digital P.I., single character
US-PC13H	145-05097-301	P.C. board for horizontal Digital P.I., single character
US-PC13J	145-05098-302	P.C. board for vertical Digital P.I., double character
US-PC13K	145-05097-302	P.C. board for horizontal Digital P.I., double character
US-B30	467-00022-007	Black Bezel retainer for Digital Position Indicator
US-B31	467-00020-007	Black Bezel for Digital Position Indicator
US-B31A	467-00021-007	Clear Bezel for Digital Position Indicator
US-B32	167-03005-700	Red Lens for Digital Position Indicator

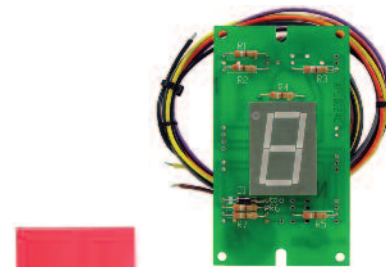

US-PC13G



US-B32



US-B30

Gongs

S.E.E.S. #	O.E.M.#	Description
US-B8A	167-31002-001	Gong assembly, Horizontal, Single lamp, Relay Controller
US-B8C	167-31002-002	Gong assembly, Horizontal, Single lamp, Microprocessor
US-B8B	167-31003-001	Gong assembly, Horizontal, Double lamp, Relay Controller
US-B8D	167-31003-002	Gong assembly, Horizontal, Double lamp, Microprocessor
US-B8E	167-31000-001	Gong assembly, Vertical, Single lamp, Relay Controller
US-B8G	167-31000-002	Gong assembly, Vertical, Single lamp, Microprocessor
US-B8F	167-31001-001	Gong assembly, Vertical, Double lamp, Relay Controller
US-B8H	167-31001-002	Gong assembly, Vertical, Double lamp, Microprocessor
US-B24A	940-31002-000	Lamp Socket .5" O.D. with clips, for gongs

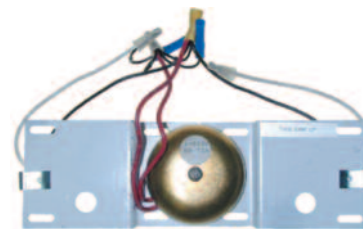

US-B8D

Capacitors

S.E.E.S. #	O.E.M.#	Description
US-CAP1	936-50004-000	Capacitor 0.25Mfd, 600V
US-CAP2	936-10032-000	Capacitor 300Mfd, 150V
US-CAP3	936-60022-000	Capacitor 108-130Mfd, 330VAC
US-CAP3A	936-60022-001	Capacitor 215-260Mfd, 330VAC
US-CAP4	936-40003-000	Capacitor 320Mfd, 450VDC
US-CAP5	936-10027-000	Capacitor 150Mfd, 150VDC
US-CAP6	936-60042-000	Capacitor 5300Mfd, 100VDC



US-CAP2



US-CAP4, 5, 6



US-CAP1



US-CAP3, 3A

Car Signal Components



Key Switches

S.E.E.S. #	O.E.M.#	Description
US-KS1-HALL		Fire Service Phase I , round key switch, BYPASS/OFF/ON, 2Pos, remove 2, for hall use, BYPASS at 10, OFF at 12, ON at 2, Uses #1 key
US-KS1-CAR		Fire service Phase II , round key switch, OFF/HOLD/ON for car use, OFF at 10, HOLD at 12, On at 2, Uses #1 key
US-KS1-OFF-ON		Keyswitch , round, red, fire service, removable 2 position "OFF-ON", Uses #1 key y
US-KS2-HALL		Fire service Phase I , square key switch, BYPASS at 10, OFF at 12, ON at 2 #1 key
US-KS2-CAR		Fire service Phase II , square key switch, OFF at 10, HOLD at 12, ON at 2, Uses #1 key
US-KS2-2	3199-153	Key Switch , 3 position spring return to center UP-OFF-DOWN, Uses #2 key
US-KS2-3	D3159-050	Key Switch , 2 position spring return to off, Uses #2 key
US-KS2A		Key , USE#1 for Fire Service Phase 1 & 2
US-KS2B		Key , USE#2 for Hall and Car Access and Inspection
US-KS2B-1	D3158-053L	Key Switch , key switch 2 position, 2 Remove, ON-OFF DPDT, Uses #2 key
US-KS3	167-03046-001	Key Switch , Run/Stop, Black, two position round switch to replace stop switch, Uses # 3 key
US-KS3-3	3199-153W/US	Key Switch , UP-OFF-DOWN, spring return center Uses # 3 key
US-KS3B		Direction Run Switch , 3 Position UP-OFF-DOWN. Spring return to center (OFF) position. Keyed to USE#3 key.
US-KS3-R		Key Switch , Run/Stop, Red, two position round switch to replace stop switch
US-KS3A		Key , USE#3 for Light, 1 & 2 Speed Fan, Fan and Light, Door Hold, Run Stop, Hall Park
US-KS4		Key Switch , Run/Stop, Black, DPDT, removeable both square switch to replace stop switch, Uses # 3 key
US-KS4-1	D3158-053S	Key Switch , 2 position key switch OFF-ON, Uses # 4 key
US-KS4A		Key , USE#4 for Ind. Svc., Hospital Emergency, Lockout, Car Park
US-KS4-R		Key Switch , Run/Stop, Red, two position square switch to replace stop switch, Uses # 3 key
US-KS5A		Key , USE#5 for Car and Hall Floor Lockout
US-KS5-CALL		Call Key Switch , Black, Round OFF-ON, 2Pos spring return, Uses # 5 key
US-KS5-LOCKOUT		Lockout Key Switch , Black, Round OFF-ON, 2Pos Remove 2, Uses # 5 key

Car Signal Components

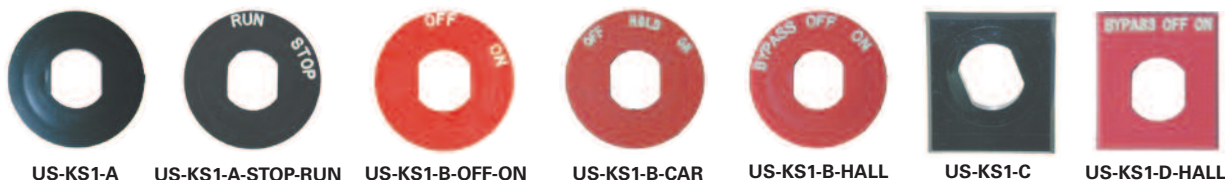

Bezels

S.E.E.S. #	O.E.M.#	Description
US-KS1-A	467-01014-001	Bezel, round black blank, 1-3/4" O.D., raised inner ring 1-9/16" O.D., 3/4" I.D., 2 straight sides
US-KS1-A-STOP-RUN		Bezel, round black as above, marked "RUN/STOP"
US-KS1-A-OFF-ON		Bezel, round, black, OFF @ 12:00 & ON @ 3:00
US-KS1-B-OFF-ON	M/F US-KS1-B	Bezel, round, red, OFF @ 12:00 & ON @ 3:00
US-KS1-B	467-01014-102	Bezel, round, red blank, 1-3/4" O.D., raised inner ring 1-9/16" O.D., 3/4" I.D., 2 straight sides
US-KS1-B-CAR		Bezel, round red, marked "OFF/HOLD/ON"
US-KS1-B-HALL		Bezel, round red, marked "BYPASS/OFF/ON"
US-KS1-C	467-01015-001	Bezel, square black, blank, 1-5/8" H x 1-7/16" W, raised inner ring 10/16" O.D. w/ 3/4" I.D. w/ 2 straight slanted inner sides
US-KS1-D	467-01015-102	Bezel, square red, blank, 1-5/8" H x 1-7/16" W, raised inner ring 10/16" O.D. w/ 3/4" I.D. w/ 2 straight inner sides
US-KS1-D-CAR		Bezel, square red marked "OFF/HOLD/ON"
US-KS1-D-HALL		Bezel, square red marked "BYPASS/OFF/ON"
US-KS1-E	467-05022-001	Backing plate, round black 2" O.D. 3/4" I.D., 2 flat outer sides (1-3/4" O.D.)
US-KS1-F		Bezel, square, black, 1-5/8" H x 1-7/16" W, raised inner ring 10/16" O.D. with 3/4" I.D. with 2 straight slanted inner sides marked "RUN/STOP"



US-KS1-E



US-KS1-F

Fuses

S.E.E.S. #	O.E.M.#	Description
F-5SB	930-15016-000	Fuse, 0.1 amp, 250V, Slo-Blo
F-12SB	930-15001-000	Fuse, 0.30 amp, 250V, Slo-Blo
F-11SB	930-15020-000	Fuse, 1.25 amp, 250V, Slo-Blo
F-32SB	940-18009-000	Fuse, 5 amp, 125V, Slo-Blo
F-17A	930-15004-000	Fuse, 0.75 amp, 250V
F-19	930-15006-000	Fuse, 2 amp, 250V
F-20	930-15007-000	Fuse, 3 amp, 250V
F-23	930-15009-000	Fuse, 6 amp, 250V
F-26	930-15010-000	Fuse, 10 amp, 250V
F-30	940-18001-000	Fuse, 1 amp, 250V, one-time
F-33	940-18002-000	Fuse, 3 amp, 250V, one-time
F-36	940-18003-000	Fuse, 6 amp, 250V, one-time
F-38	940-18004-000	Fuse, 10 amp, 250V, one-time
F-40	940-18005-500	Fuse, 15 amp, 250V, one-time
F-41	940-18006-000	Fuse, 20 amp, 250V, one-time



F-5SB thru F-32SB



F-17A thru F-26



F-30 thru F-41

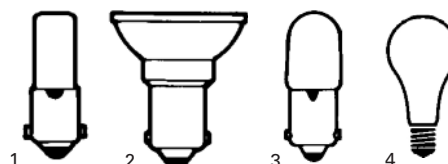

Lamps

Fig.	S.E.E.S. #	O.E.M.#	Description
1	ML-8	930-27004-000	Lamp, 60MB, 60V
2	ML-27	930-27007-000	Lamp, 60RB, 60V
3	ML-68	940-24001-000	Lamp, 313, 28V
4	ML-141	940-24004-000	Lamp, 100 A/CL, utility lamp 100W, 230-250V
	US-B24		Lamp socket for buttons
	US-B24A		Lamp socket for gongs



Printed Circuit Boards and Timers

SN

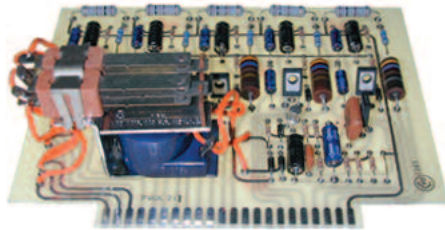

US-PC1

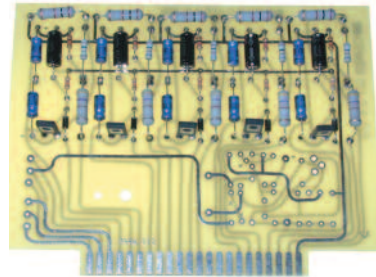

US-PC2



US-PC3



US-PC4



US-PC5



US-PC5A

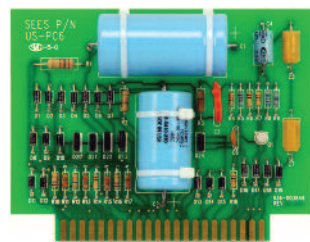

US-PC6

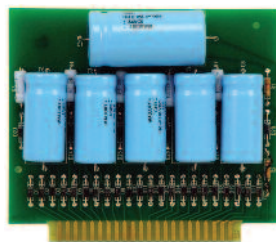

US-PC7

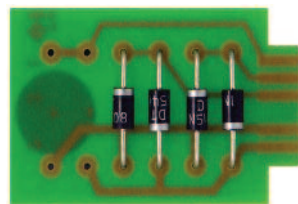

US-PC8

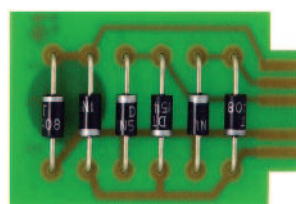

US-PC9

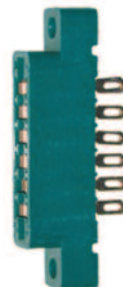

US-PC9B



US-PC-10

■ Octal base plug-in timer

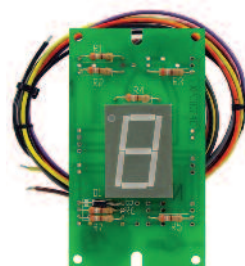

US-PC13G

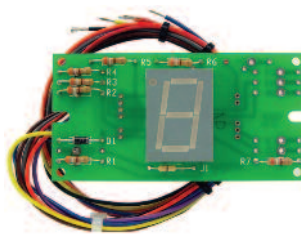

US-PC13H

S.E.E.S. #	O.E.M.#	Description
US-PC1	153-05008-300	Car Top Amplifier w/ nudging
US-PC2	153-05008-301	Car Top Amplifier w/o nudging
US-PC3	144-00032-001	Reverse Phase Amplifier
US-PC4	144-00020-001	Amplifier, Photo Cell Sensor
US-PC5	144-00019-001	Receiver, Photo cell sensor
US-PC5A	144-00018-001	Lamp holder assembly, photo eye, for 60 RB Lamp.
US-PC6	144-00016-001	Hydro Control Board #1
US-PC7	144-00017-001	Hydro Control Board #2
US-PC8	144-00065-001	Rectifier Board
US-PC9	144-00066-001	Rectifier Board
US-PC9B	930-11059-000	Base for US-PC9 rectifier
US-PC10	144-00035-001	Timer, External Relay .5-5 Sec.
US-PC11	144-00039-001	Timer, External Relay .5-60 Sec.
US-PC12	144-00041-001	Timer, Internal Relay N/O .5-60 Sec
US-PC13	144-00067-001	Timer, Internal Relay N/C .5-60 Sec
US-PC13G	154-05006-301	Position Indicator PC Board Vertical, Single
US-PC13H	154-05005-301	Position Indicator PC Board Horizontal, Single

Printed Circuit Boards and Timers

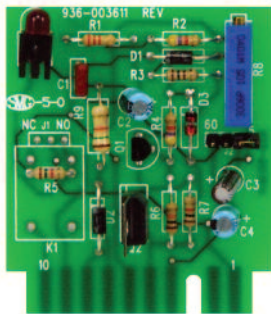

US-PC13A

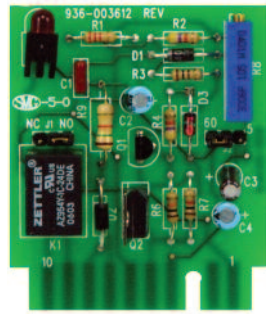

US-PC13B

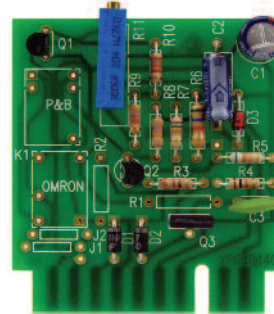

US-PC13F

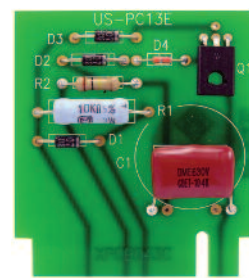

US-PC13E

S.E.E.S. #	O.E.M.#	Description
US-PC10A	145-05064-301	Timer, .5-5 Sec.
US-PC13A	145-05064-304	Timer, N/C .5-60 Sec.
US-PC13B	145-05064-303	Timer, N/O .5-60 Sec.
US-PC13F	145-05064-302	Timer, .5-60 Sec.
US-PC13E	145-05063-300	Reverse Phase Amplifier, printed circuit board
US-PC13D	144-00099-002	Adapter, Grey, for N/O, N/C & reversed phase timers
US-PC13C	144-00099-001	Adapter, White, for .5-5 & .5-60 second timers
US-PC16	920-27026-000	Power Supply, Ascension 1000
US-PC17	146-05071-300	Power Board MP1230
US-PC18	146-05620-300	Board, Central Processing Unit, US1000
US-PC19	146-05630-300	PC Board, H4 I/O
US-PC20	920-27026-000	Power Supply Board

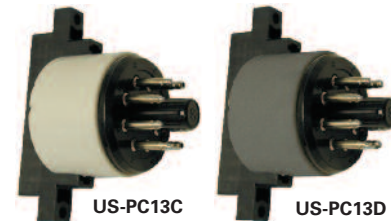

US-PC13C

US-PC13D

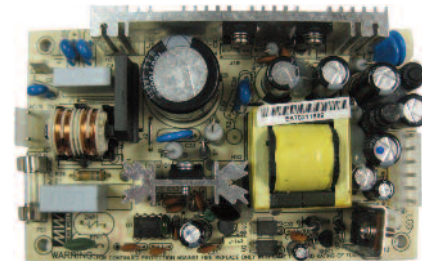

US-PC16

Amtech

S.E.E.S. #	Description
AMT-1	Omega 1000 Peripheral
AMT-2	Stepper PC Solid State
AMT-3	Level Sensor Decoder
AMT-4	Door Operator Control Board

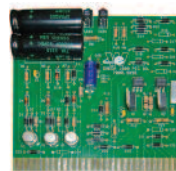

AMT-1

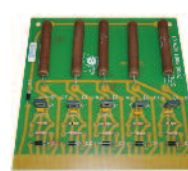

AMT-2

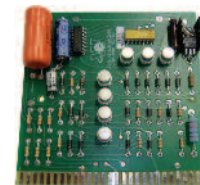

AMT-3



AMT-4

Relays

S.E.E.S. #	O.E.M.#	Description
PR-20	930-35029-000	Starter, reversing contactor 4PDT, 48VDC
US-R12	930-35030-000	Relay, Type KUP, DPDT, 48 VDC
PR-38	930-35031-000, 930-35032-000	Relay, Flange mount, 3PDT Type KUP 48VDC
US-R14	930-35033-000, 930-35033-000	Relay, Flange mount Type KUP 3PDT 240VAC
US-R18	930-35053-000	Relay, Plug in Type K10-2P, 48VDC

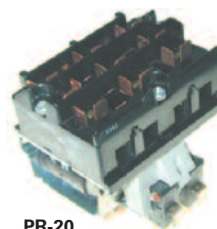

PR-20



PR-38



US-R18

Relays



US-R42

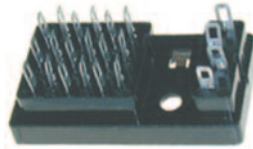

US-R43A



ORP-45



PR-28TC



PR-28BC



US-R43



US-R44

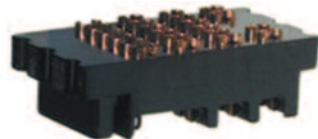

PR-35

IBM Relay Base

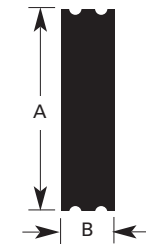

PR-31



PR-35T

No. of Contacts	A	B
4 PDT	2"	5/8"
6 PDT	2"	15/16"
12 PDT	2"	1-7/8"

■ Relay Dimensions listed for identification assistance.

S.E.E.S. #	O.E.M.#	Description
US-R42	930-35051-000, 930-35037-000	Relay, Type R10-4PDT, 48VDC
US-R42A	930-37014-000	Base, Socket for 4PDT, R10-relay
US-R43	930-35052-000	Relay, R10-6PDT, 48VDC
US-R43A	930-37015-000	Base, Socket for R10-6PDT relay
US-R44	930-35038-000	Latch Relay, R10-4P, 48VDC
US-R44A	930-02001-000	Base, Socket for R10-4P Latch
ORP-45	930-35056-000	Relay, VC152A2B-120VAC
ORP-45A	930-35056-001	Relay, VC153A1B-120VAC
ORP-45B	930-35056-002	Relay, VC154A-120VAC

IBM Relays

S.E.E.S. #	O.E.M.#	Description
PR-28-BC		Clip, bottom hold down clip for relay
PR-28-TC		Clip, top hold down clip for relay
PR-30	930-35019-000, 769489	Relay, IBM 4PDT, 48VDC
PR-30S		Solid State Replacement for PR-30
PR-33	930-35017-000, 186685	Latching Relay, IBM 4PDT, 45VDC
PR-33S		Solid State Replacement for PR-33
PR-35	930-02000-000	Base, for 4PDT IBM relays
PR-31	930-02001-000, 769019	Relay, IBM 6PDT, 48VDC
PR-31S		Solid State Replacement for PR-31
PR-35C	930-35018-000	Base, for IBM 6PDT relay
PR-35E	136267	Arc Suppressor Assy, Diode 3A, 50V for PR-35
PR-34	930-35020-000, 769488	Relay, IBM 12PDT, 48VDC
PR-34S		Solid State Replacement for PR-34
PR-35D	930-02002-000, 159943	Base, for IBM 12PDT relay
PR-35A	930-35004-000	Wire Contacts for all IBM Wire Relays
PR-35B		Taper pins for base wiring
PR-35T		Tool, IBM contact removal and insertion tool

Tube Base Relays



US-R1

S.E.E.S. #	O.E.M.#	Description
US-R1	930-35008-000, 930-35014-000	Delay Relay, Amperite, 50V, N.O., 60 sec
US-R2	930-35009-000, 930-35012-000	Delay Relay, Amperite, 50V, N.O., 30 sec
US-R3	930-35010-000	Delay Relay, Amperite, 50V, N.O., 5 sec
US-R4	930-35011-000	Delay Relay, Amperite, 50V, N.O., 2 sec
US-R5	930-35013-000	Delay Relay, Amperite, 50V, N.O., 180 sec
US-R6	930-35015-000	Delay Relay, Amperite, 50V, N.O., 10 sec
US-R7	930-35026-000	Delay Relay, Amperite, 50V, N.O., 8 sec

Resistors



RES-53 thru RES-61

Adjustable Resistor 10-1/2"

S.E.E.S. #	O.E.M.#	Description		
RES-53	934-10055-000	Resistor	10 ohm	200 Watt
RES-54	934-10054-000	Resistor	25 ohm	200 Watt
RES-55	934-10063-000	Resistor	50 ohm	200 Watt
RES-56	934-10057-000	Resistor	100 ohm	200 Watt
RES-58	934-20206-000	Resistor	200 ohm	200 Watt
RES-59	934-10056-000	Resistor	250 ohm	200 Watt
RES-60	934-10062-000	Resistor	500 ohm	200 Watt
RES-61	934-10060-000	Resistor	1K ohm	200 Watt



RES-71

S.E.E.S. #	O.E.M.#	Description		
RES-71	934-10061-000	Resistor	500 ohm	20W, fixed

Transformers

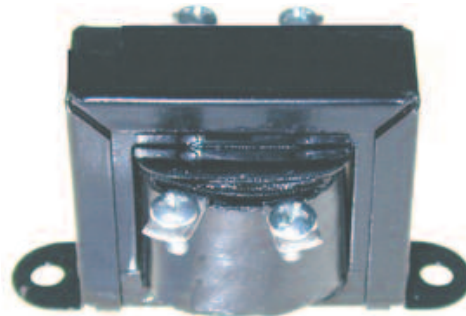

US-TR1 thru US-TR11

S.E.E.S. #	O.E.M.#	Description	Primary Voltage	Secondary Voltage
US-TR1	940-38001-000	Transformer, 5 VA, for Alarm Bell	120	10
US-TR2	940-38011-000	Transformer, 1.2A	115	6.3
US-TR3	930-45012-000	Transformer, 2-4A	115/230	12/24
US-TR4	940-38012-000	Transformer, 0.25 KVA	200/220/240	55
US-TR5	940-38008-000	Transformer, 0.25 KVA	240/480	120/240
US-TR6	940-38009-000	Transformer, 0.5 KVA	240/480	120/240
US-TR7	940-38010-000	Transformer, 1 KVA	110/ 120/130	55
US-TR8	940-38007-000	Transformer, 1 KVA	240/480	120/240
US-TR9	940-38004-000	Transformer, 3 KVA	240/480	120/240
US-TR10	448-05001-850	Transformer, 5 A for MDU	200/240	45
US-TR11	448-05004-850	Transformer, 4 A for MDU	220/260	100/100

Seals



USPAC-26

Hydraulic Split Seal Stack Packing

S.E.E.S. #	O.E.M.#	Description
USPAC-26	437-00010-000	Packing Set, 4-1/2" x 5 1/2"
USPAC-27	437-00011-000	Packing Set, 5" x 6" x 1-1/2", Split
USPAC-27A	437-00023-000	Packing Set, 5-1/2" x 6-1/2", Split Autopak
USPAC-28	437-00012-000	Packing Set, 6" x 7" x 1/2", Soft Split Autopak
USPAC-29	437-00025-000	Packing Set, 7" x 8" x 1-1/2"
USPAC-30		Seal, worm shaft for #63 Machine

Valve Kits



MIS-208G

S.E.E.S. #	O.E.M.#	Description
MIS-208G	995-00044-001	Repair Kit for UC-1, UC-2, UC-2A
MIS-208G1	995-00044-002	Repair Kit for UC-3A, UC-4

Pump Belts

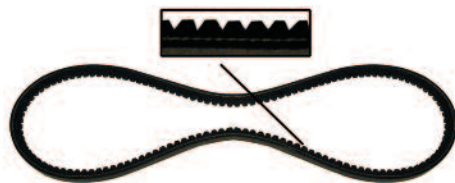

MIS-BLT8

S.E.E.S. #	O.E.M.#	Description
MIS-BLT8	990-10105-000	V-Belt 3V375/3VX375
MIS-BLT14	990-10103-000	V-Belt 3V530/3VX530
MIS-BLT15	990-10102-000	V-Belt 3V560/3VX560
MIS-BLT16	990-10101-000	V-Belt 3V600/3VX600
MIS-BLT17	990-10000-000	V-Belt 3V630/3VX630
MIS-BLT18	990-10106-000	V-Belt 3V670/3VX670
MIS-BLT19	990-10107-000	V-Belt 3V710/3VX710

Contact Kits

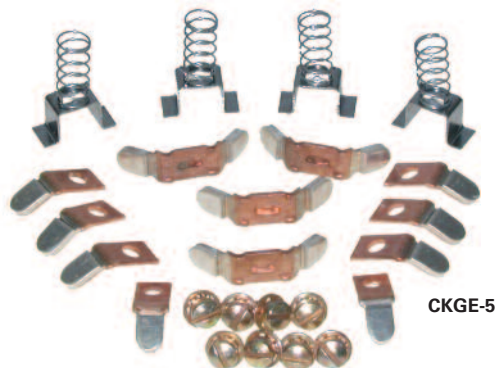

CKGE-5

S.E.E.S. #	Description
CKGE-5	Size 1, Contact Kit, 546-A301G-053, 546-A301G-002
CKGE-7	Size 2, Contact Kit, 546-A780G-002, 546-A780G-051
CKGE-9	Size 3, Contact Kit, 55-153677-G001, 55-153677-G002

Hatch Equipment

S.E.E.S. #	O.E.M.#	Description
MIS-181B	930-41014-000	Limit Switch , with roller, 1 N.O., 1 N.C.
MIS-184A	940-35011-000	Magnetic Switch , 1 N.O., 1 N.C.

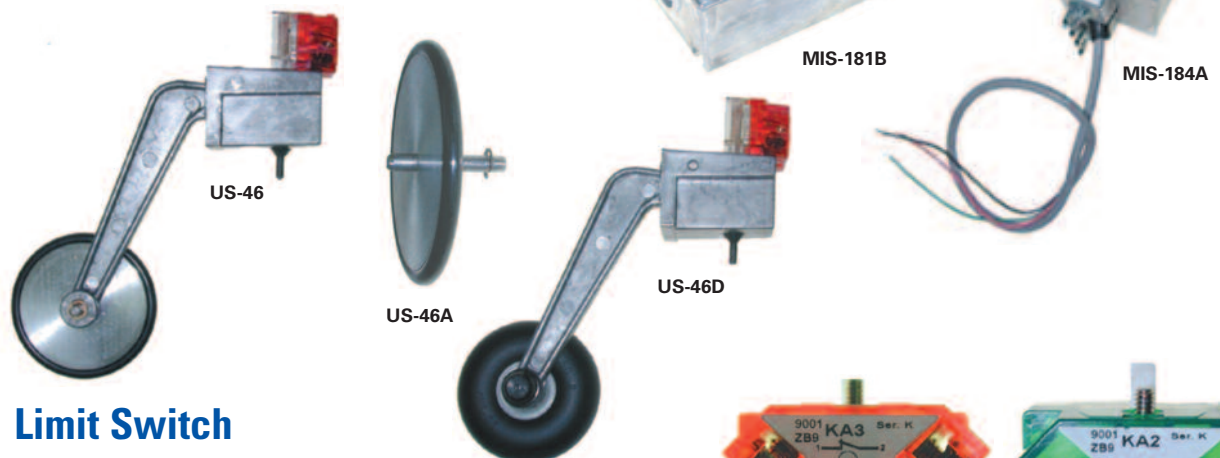

Limit Switch

S.E.E.S. #	O.E.M.#	Description
US-46	150-00116-001	Limit Switch assembly, N.C.
US-46A	940-00012-000, 150-00280-001, 150-00142-007	Roller with clip , for Limit Switch US-46
US-46B	940-02004-000	Contact Block assembly, N.C., for limit switch
US-46F	940-02004-001	Contact Block assembly, N.O., for limit switch
US-46C	990-11405-000	Retaining Ring for roller 3/16" shaft
US-46D	150-00643-001	Limit Switch , N.C., new style, with air tire
US-46E	960-00062-000	Roller for limit switch US-46D
US-46T		Tire replacement for US-46A

S.E.E.S. #	O.E.M.#	Description
MIS-119	990-00021-000	Door Key with collar.
MIS-119-P		Door Key , Flapper with Plastic Handle and flexible safety shaft
US-47		Guide Shoe Insert , 5-3/4" long, rounded back, for 8 and 16 lb. rails for assembly #960-00034-000
US-47A		Guide Shoe Insert , 5-3/4" long, slot 5/8" x 1-3/4" deep, for Model 8ST for assembly #960-00036-000
US-47B		Clip , Replacement Shoe Retainer With Hardware Used On MIS-233
MIS-233	8S	Guide shoe assembly , Esco fixed, 5/8" rail with insert
US-47C	960-0036-000	Gib Retaining Clips & Hardware for US-47, 2 req per gib
USS-001	999-0733	Tape Guide , ASC 2000 Selector



Wheels

US



USW-1

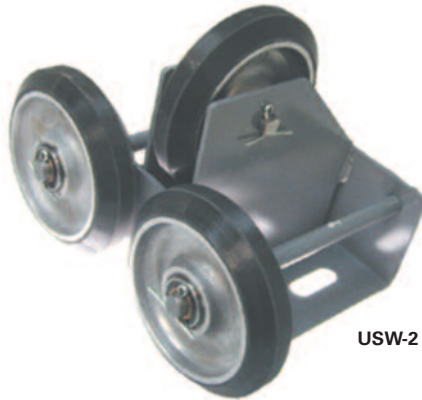

USW-2

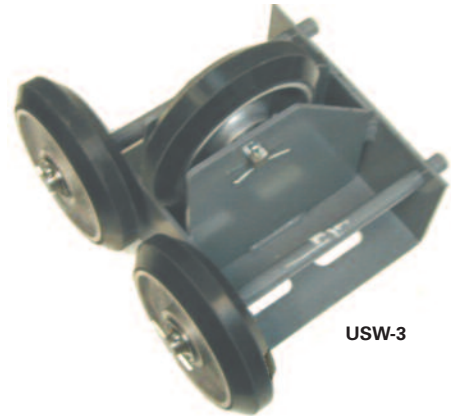

USW-3



USW-4



USW-7

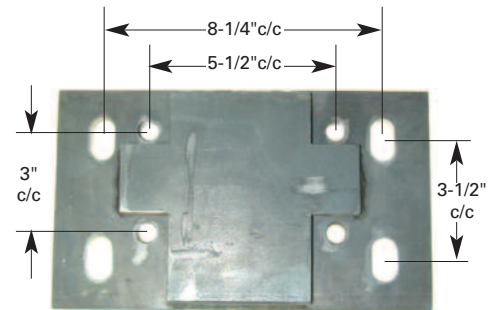

USW-36A

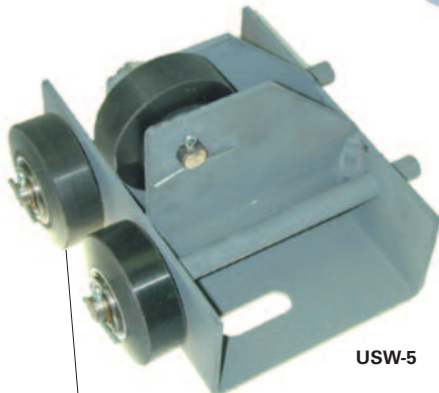

USW-5

USW-4

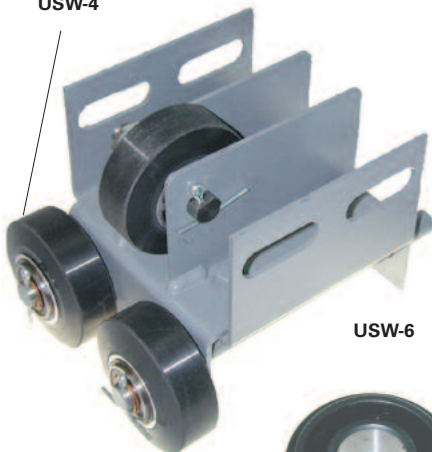

USW-6

USW-8



S.E.E.S. #	O.E.M.#	Description
USW-1	100-00080-001	Roller guide wheel 6" dia., polyurethane tire, face 5/8" W
USW-2	100-00054-001	Roller guide assembly , for Car, with 6" dia. wheels USW-1. Mounting holes 5-1/2" c/c
USW-3	100-00075-001	Roller guide assembly , 6" dia. Original mounting holes 8-1/4" c/c. Replacement kit consists of USW-2 roller guide assembly and USW-36A adapter
USW-7	100-00100-001, 100-00100-002	Bolt and Bushing Kit for 3" and 6" roller replacement
USW-36A	100-00004-001	Adapter plate for USW-2 when used to replace old style 6" diameter roller guide assembly. Bolt mounting pattern (shown above)
USW-4	114-00009-007	Roller guide wheel 3-1/4" .625" I.D., tire face 15/16" W, double bearing
USW-5	100-00057-001	Roller guide assembly for Hydro, with 3-1/4" dia. wheels (USW-4)
USW-6	114-00054-001	Roller guide assembly for counterweight, with 3-1/4" dia. wheels (USW-4)
USW-8	960-00011-000	Bearing for governor and roller guide wheels



SEES Universal Roller Guides page 302